

PACKTALK OUTDOOR INSTALLATION GUIDE 取り付けガイド

EN/JP

STUDENT 生徒用

CONTENTS 内容物

I x5

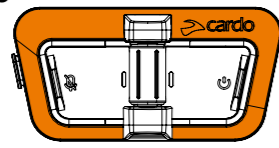

J x5

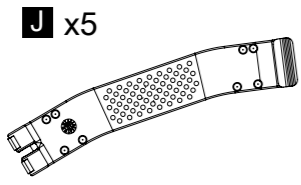

K x5

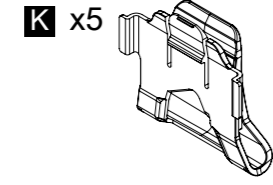

L x5

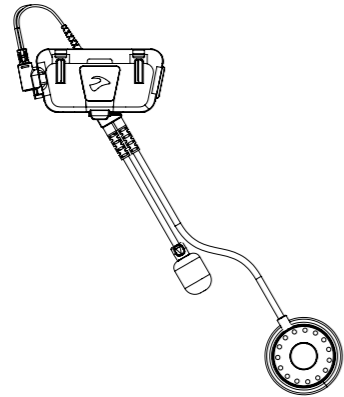

-17-

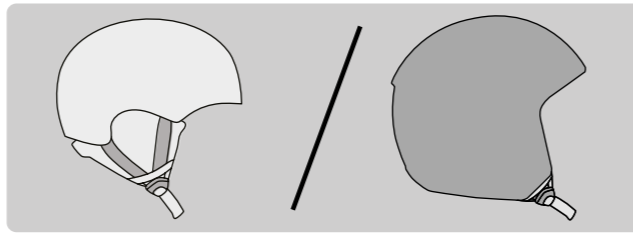

Installation Video
取り付け動画



-18-

1 MOUNT THE CRADLE クレードルの取り付け

Option 1 オプション1

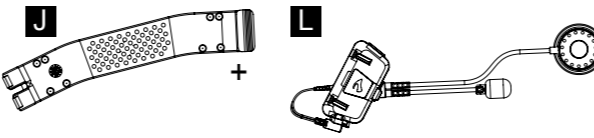
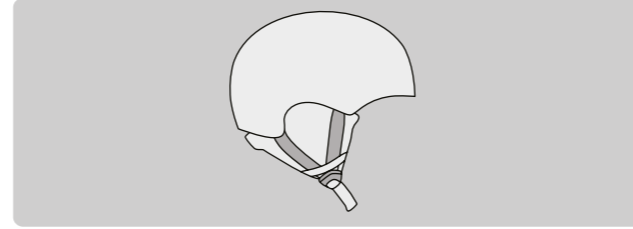

1.a

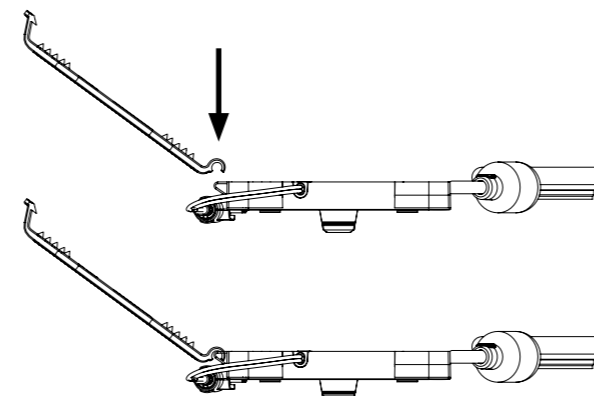

-19-

1.b

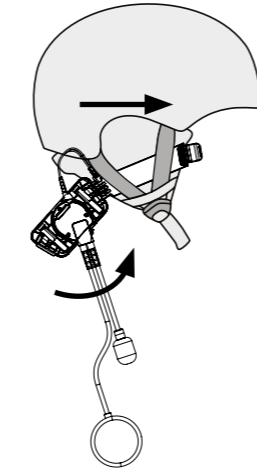

1.c

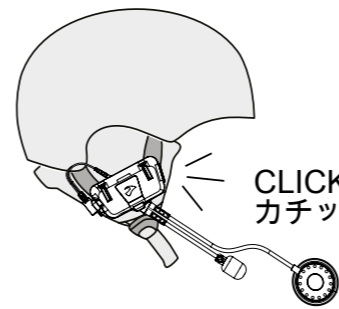

-20-

Remove Bar
バーを取り外す

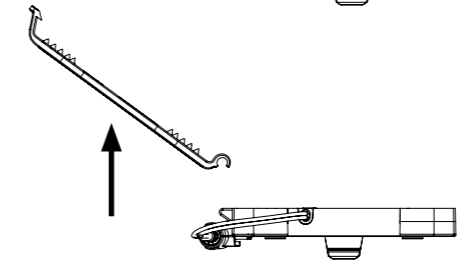
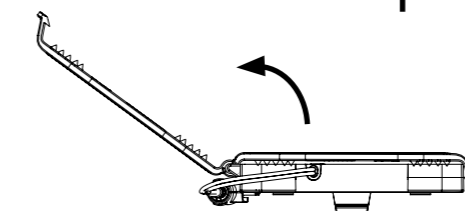
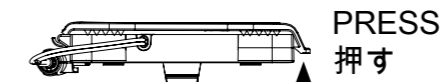

-21-

Option 2 オプション2

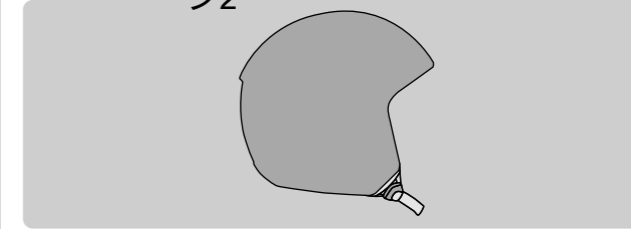

1.a*

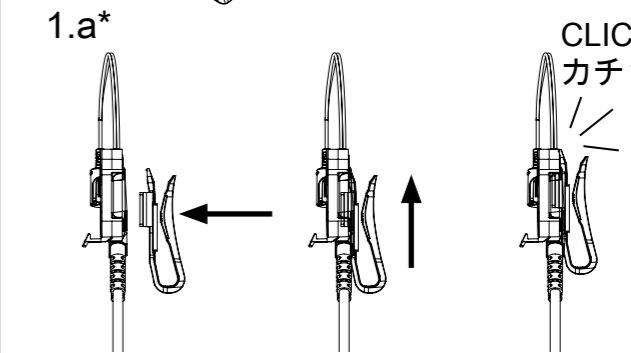
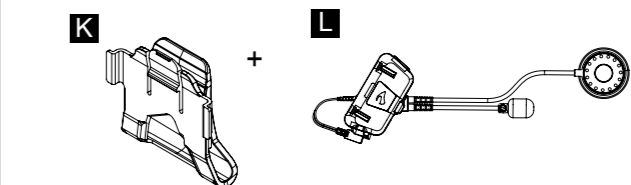

-22-

1.b*

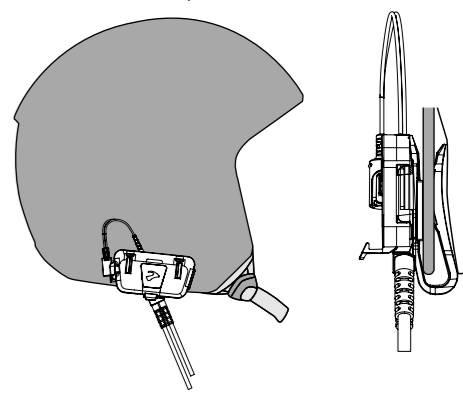
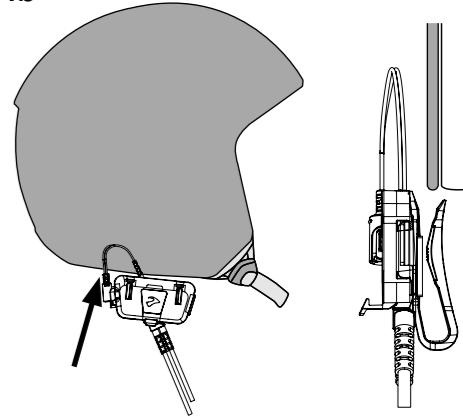

-23-

2 PLACE THE SPEAKER AND MICROPHONE スピーカーとマイクを取り付け

2.a

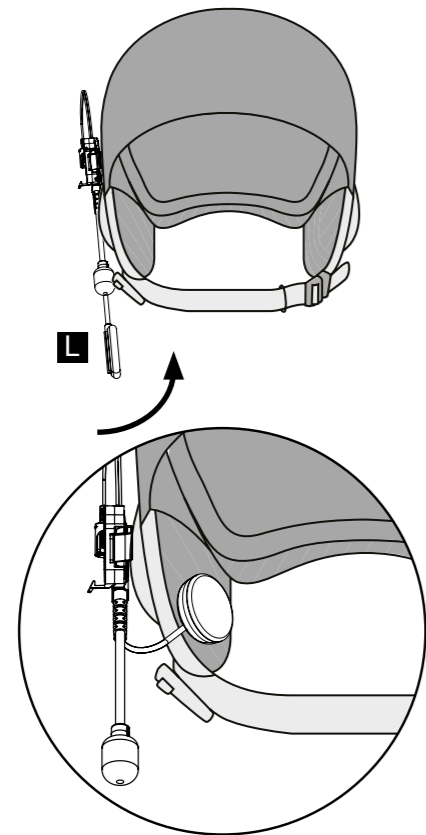

-24-

2.b

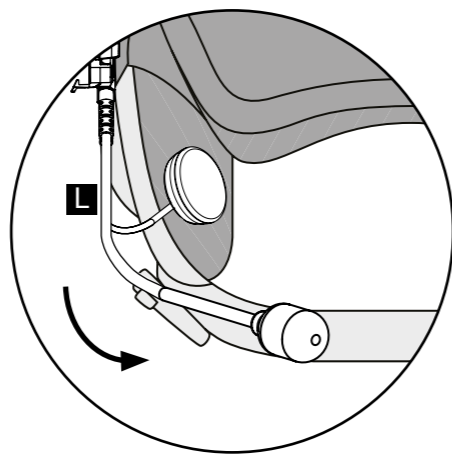

-25-

2.c

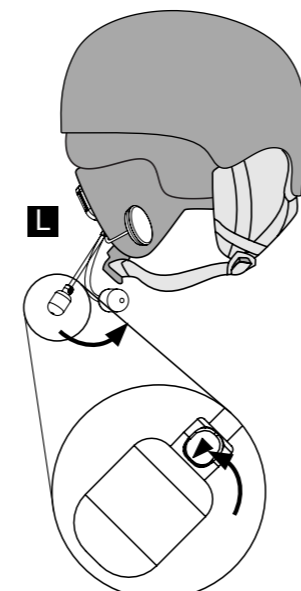

Arrow Faces Mouth
矢印を口の方向に向ける

-26-

3 INSERT UNIT ユニットの挿入

3.1

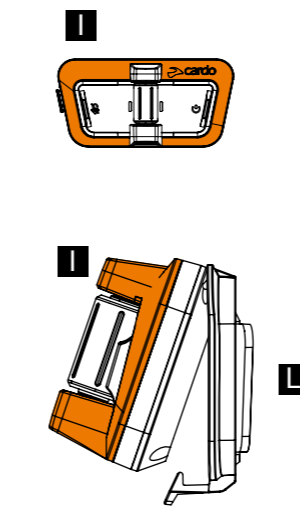

3.2

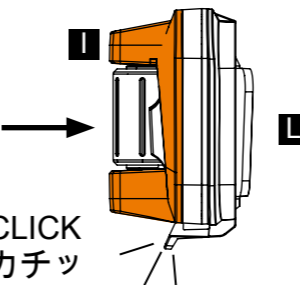

-27-

4 CONNECT AUDIO KIT オーディオキットの接続

4.1

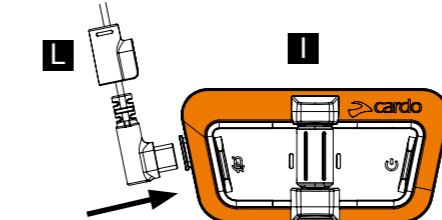

4.2

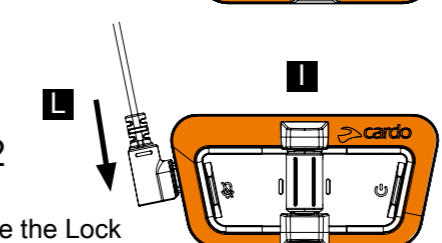

Slide the Lock
スライドしてロック

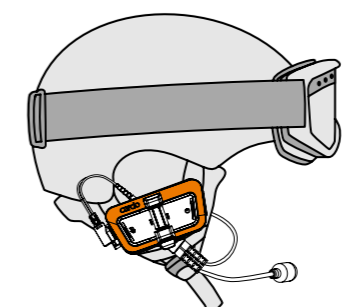

-28-

5 REMOVE THE UNIT ユニットの取り外し

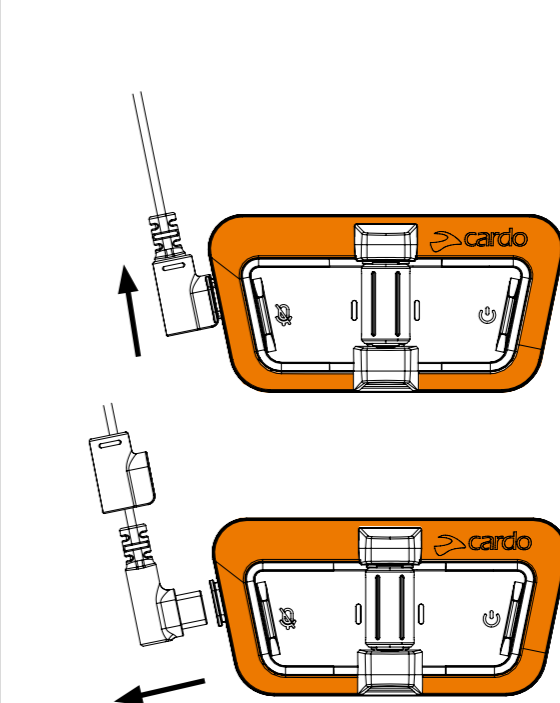

-29-

Press
押す

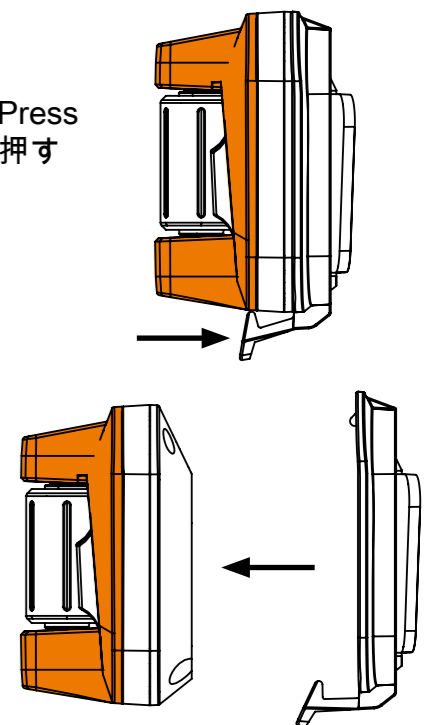

-30-

STAY IN TOUCH

Cardo support

Follow Cardo Outdoor

