

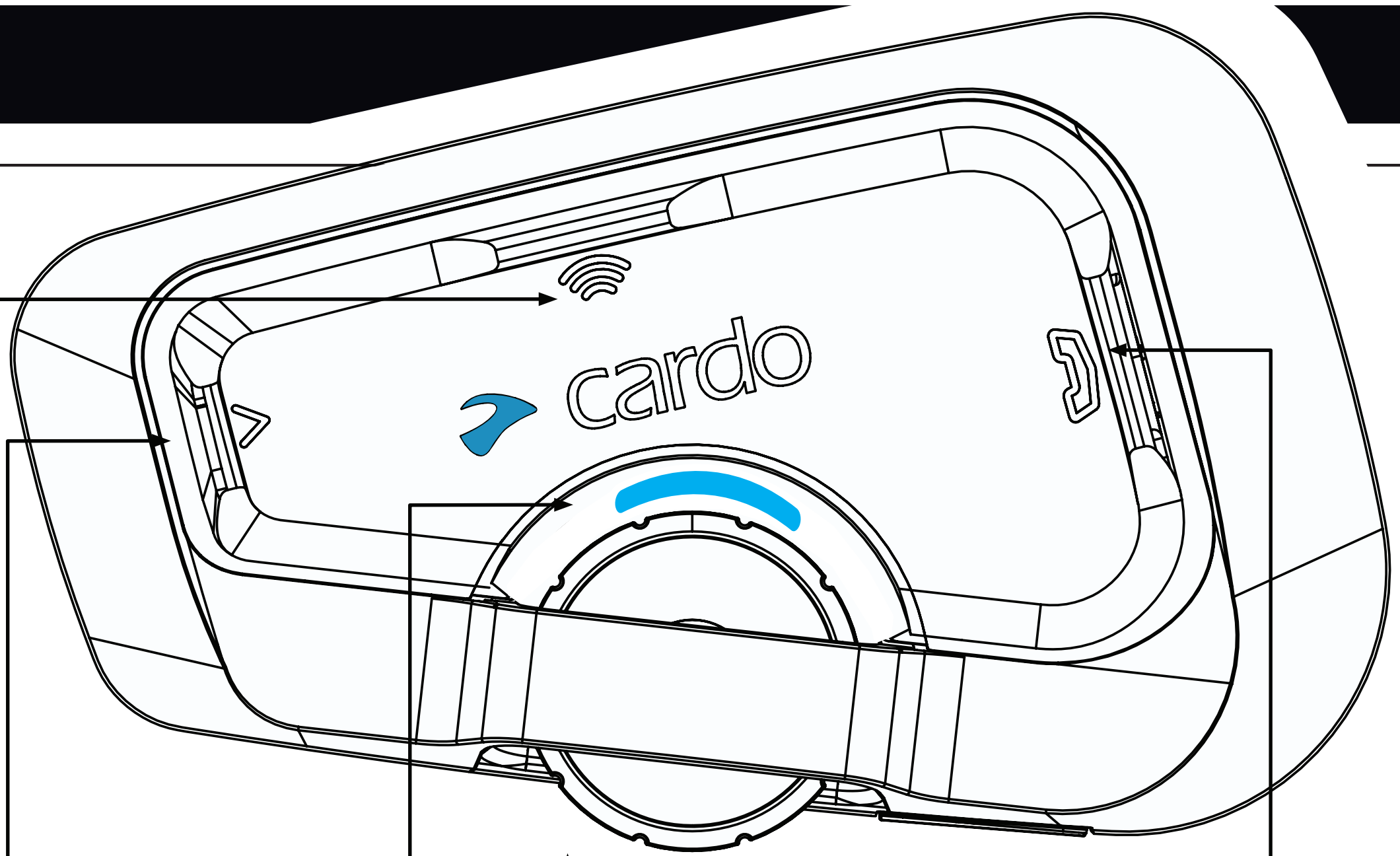

CARDO  
FREECOM 4x

.....  
ポケットガイド  
JP





メディア

モバイル

コントロールホイール

インターコム

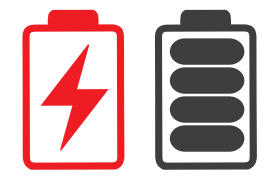

USB充電

インジケーター



長押し



タップ回数

# 利用を開始する

## 🔌 オン/オフ

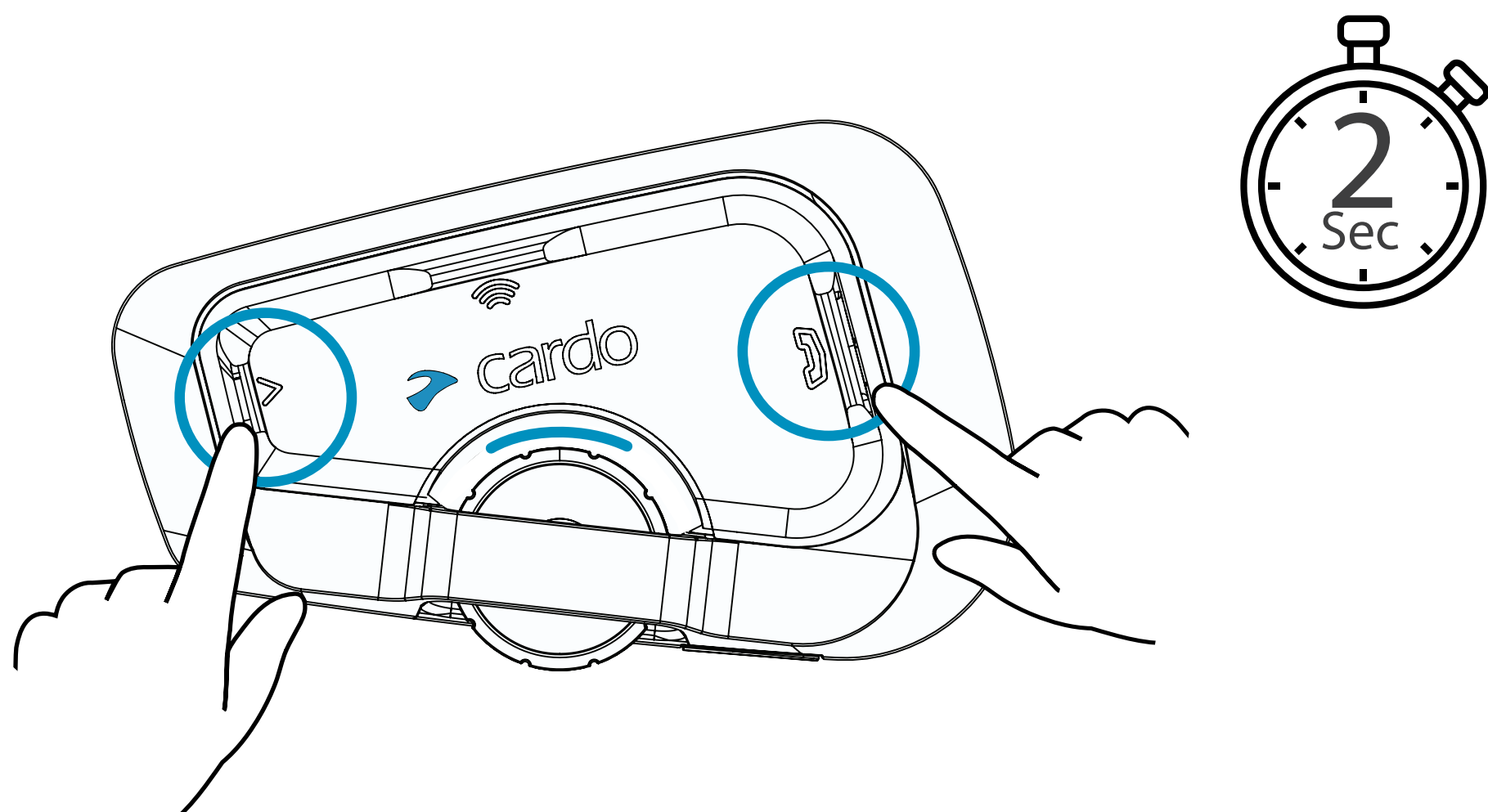

## 🔗 スマホのペアリング

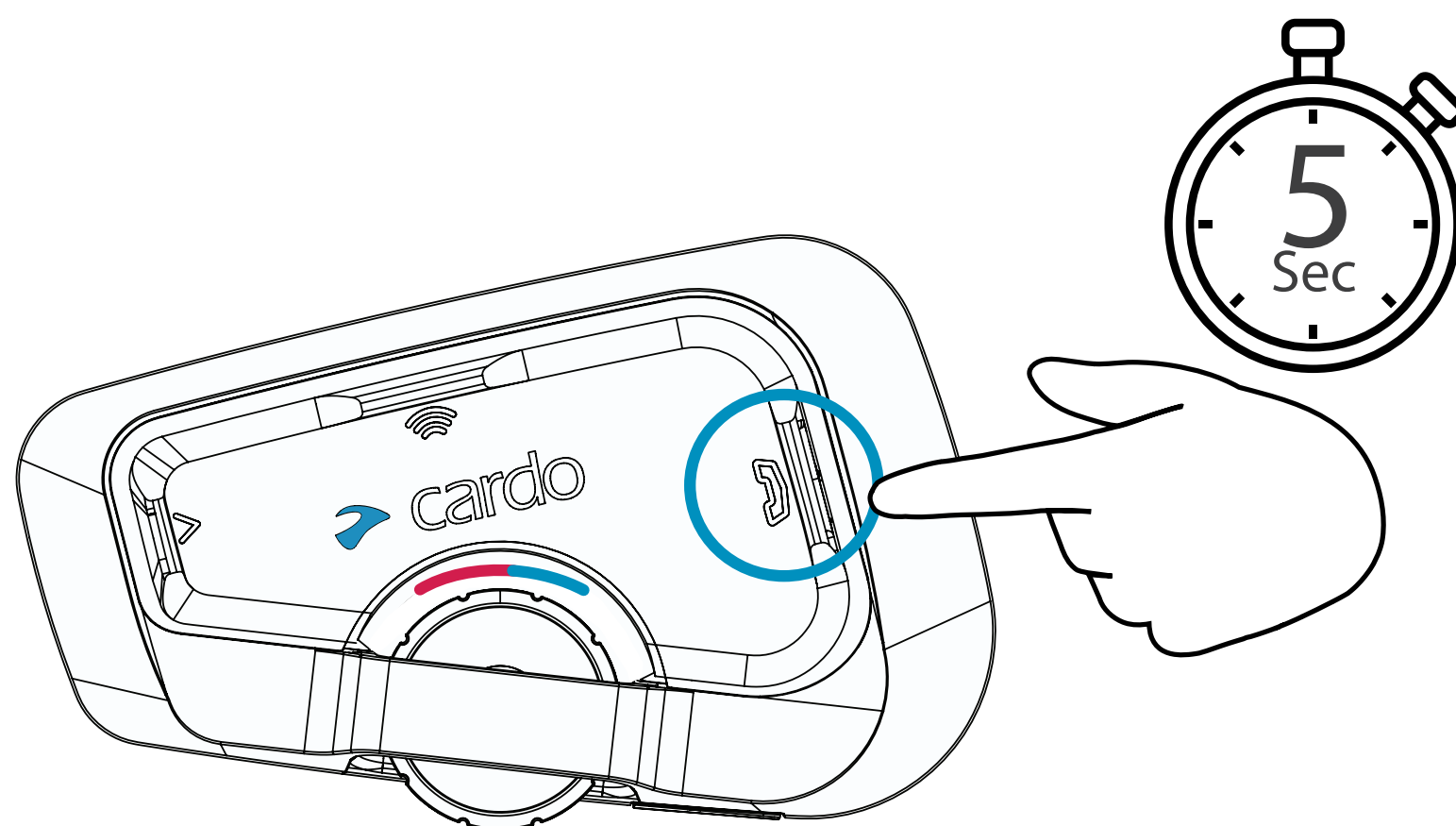

LED 赤 & 青



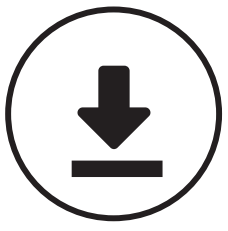

## ダウンロード



## 登録

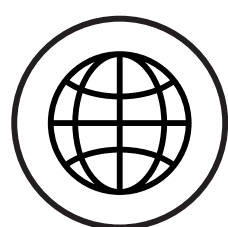
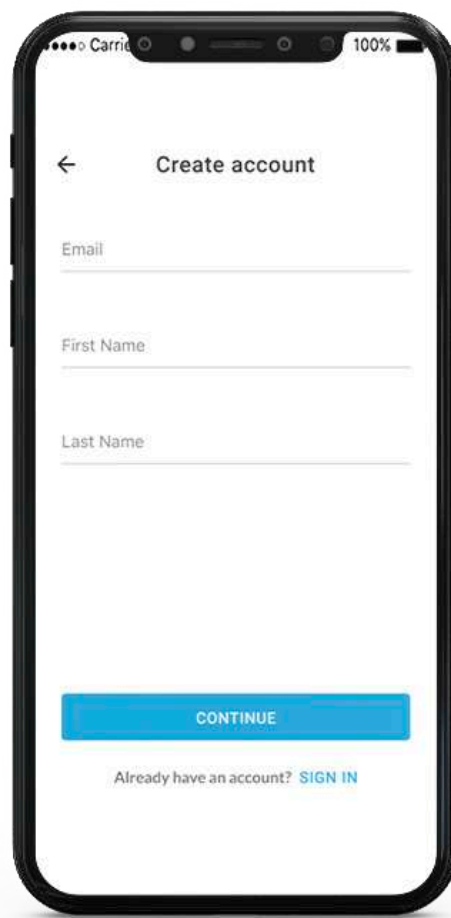

## 言語の選択

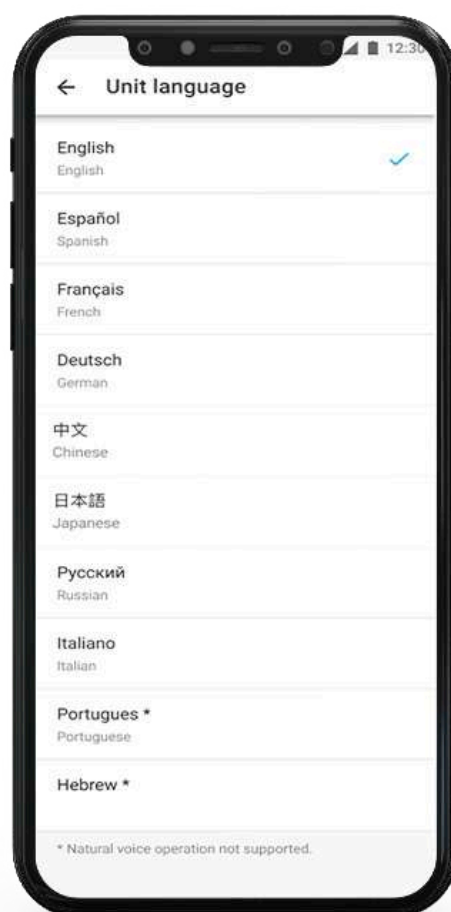

## ソフトウェアの更新

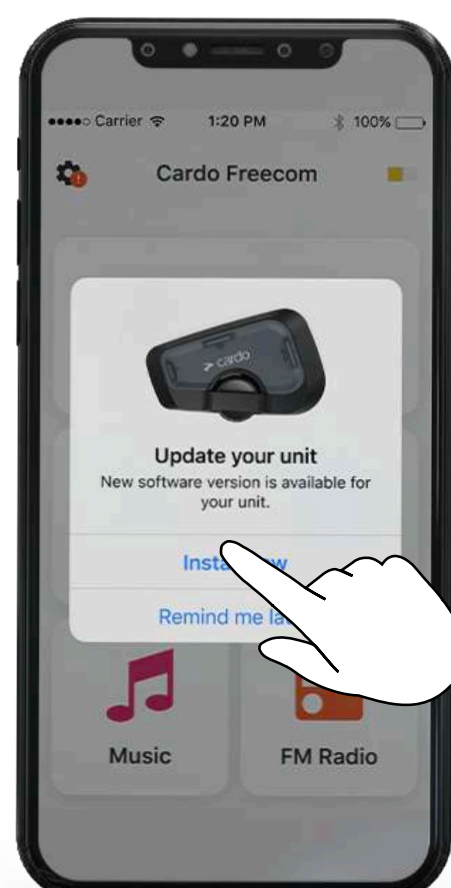

# 基本操作

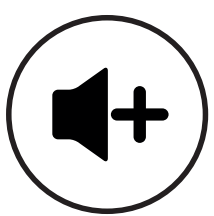

音量を上げる

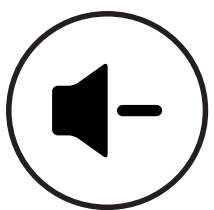
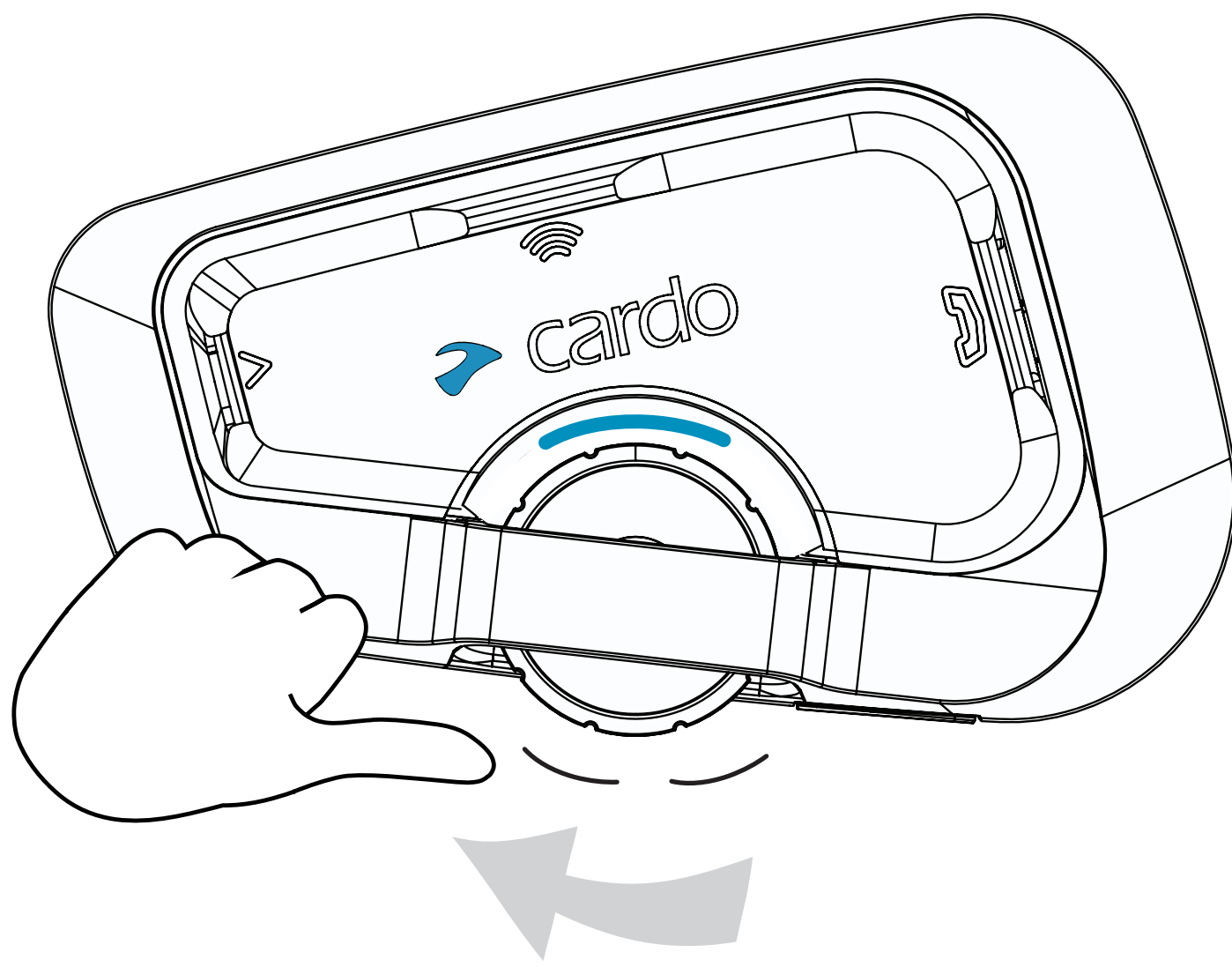

音量を下げる

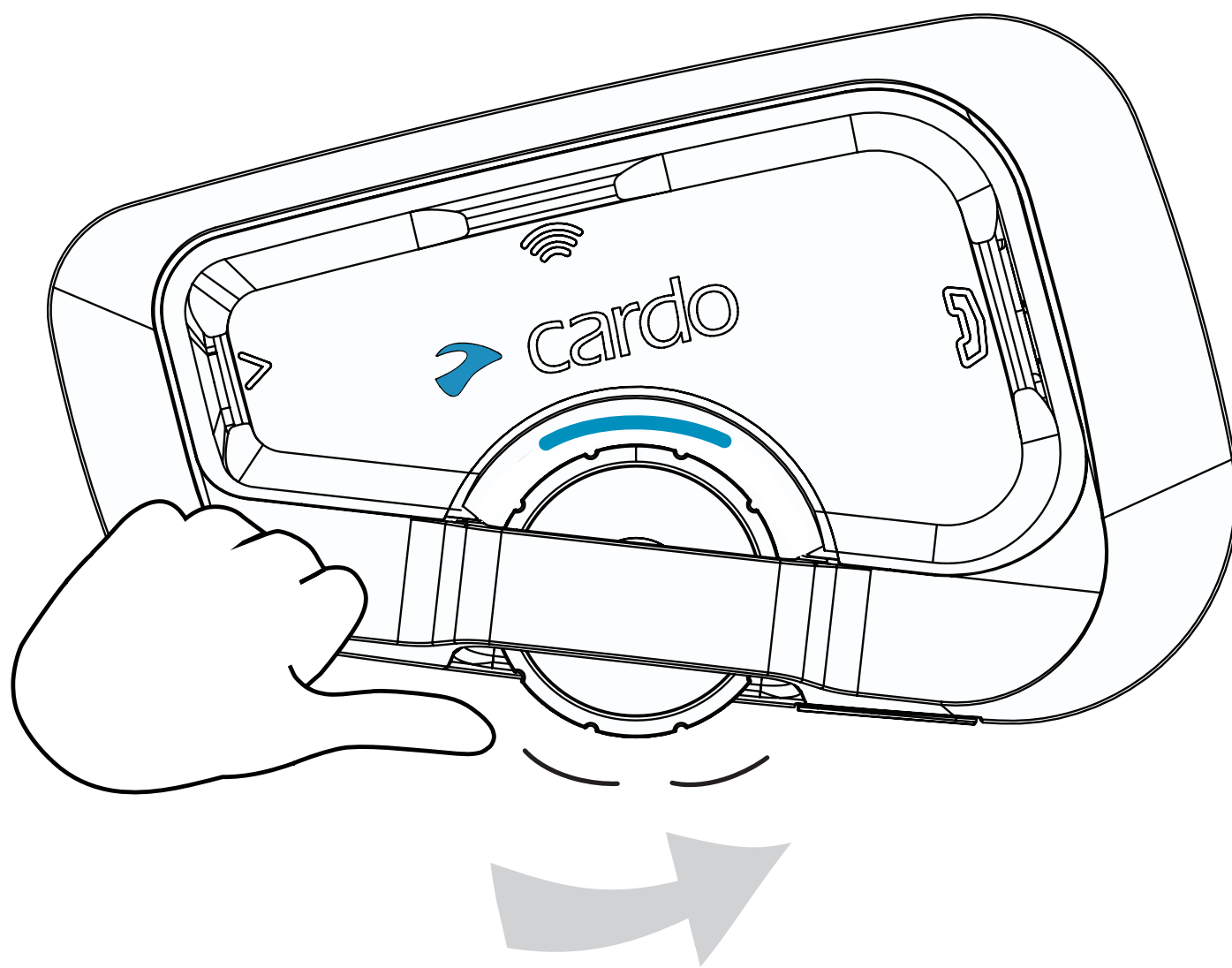

音声アシスタント

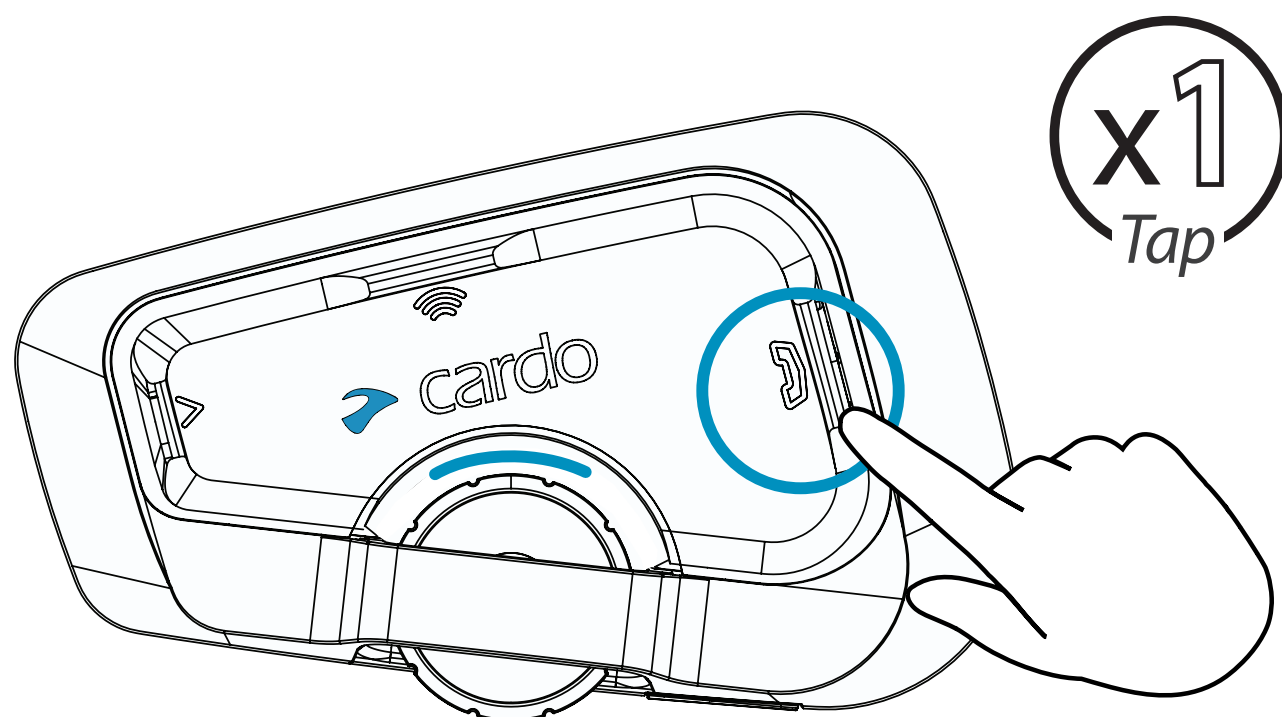

# 音楽

▶ 再生

x1  
Tap

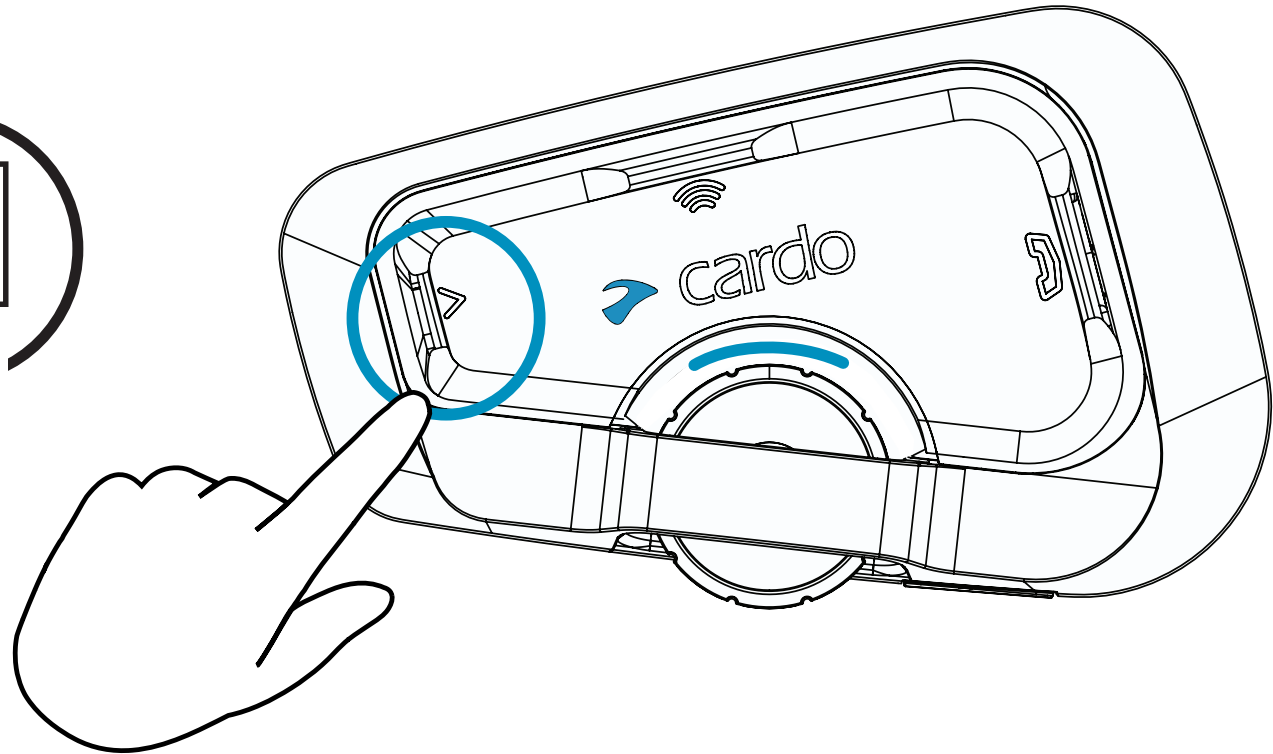

⏸ 一時停止

x1  
Tap

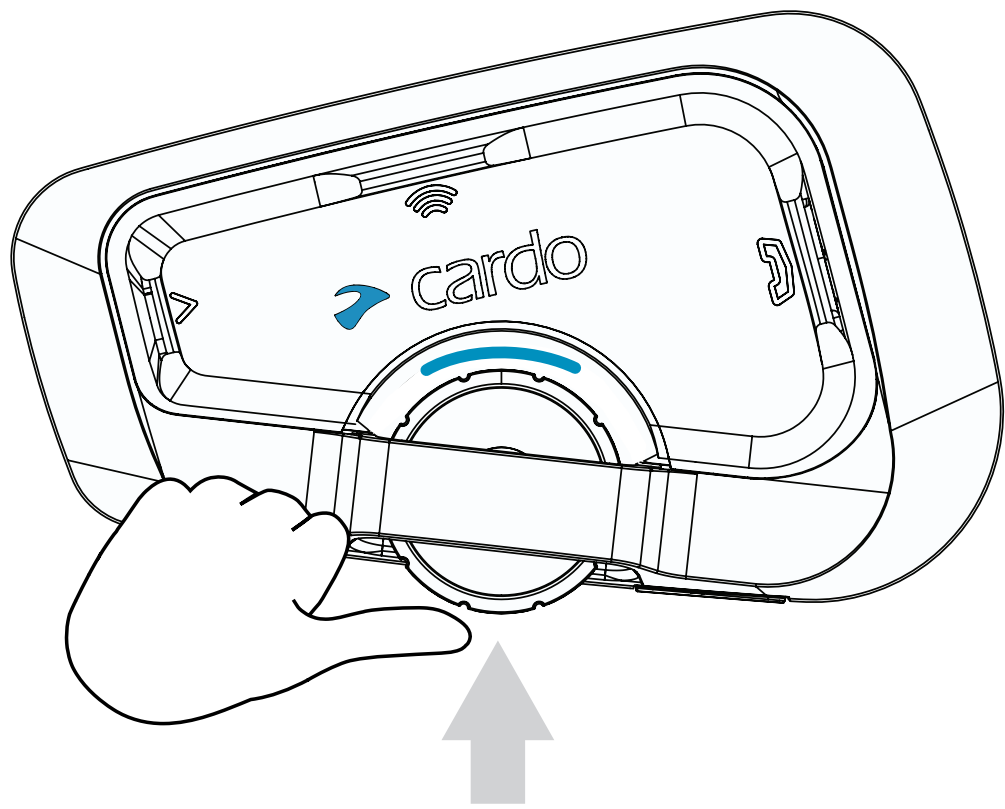

▶▶ 次へ

x1  
Tap

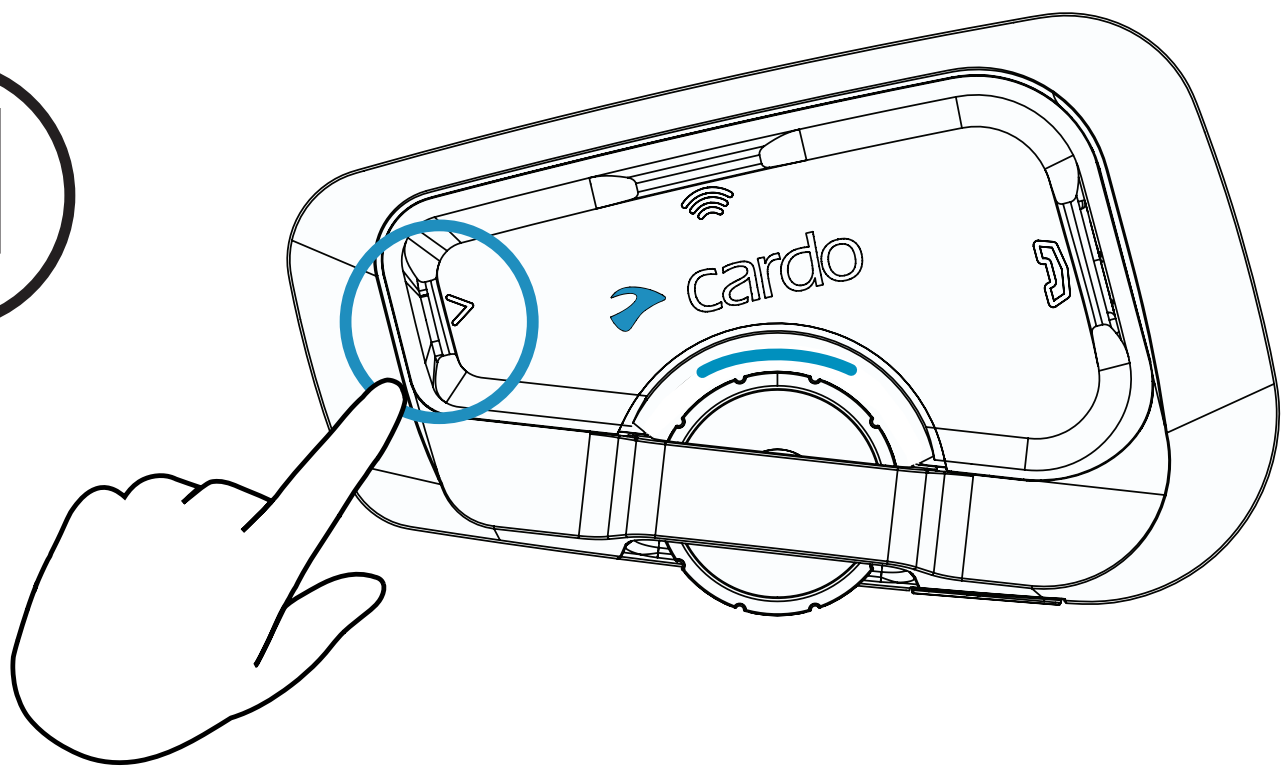

◀◀ 前へ

x2  
Tap

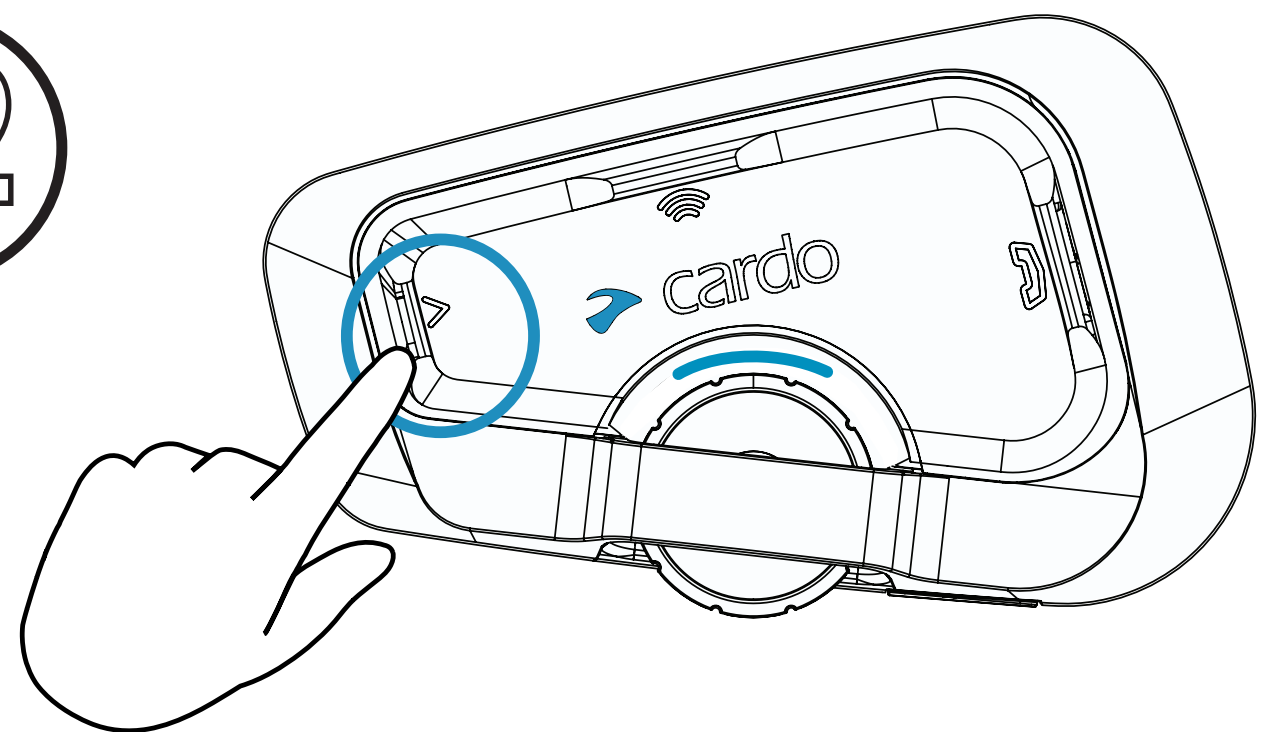

# ラジオ

## ⚙️ プリセットの設定

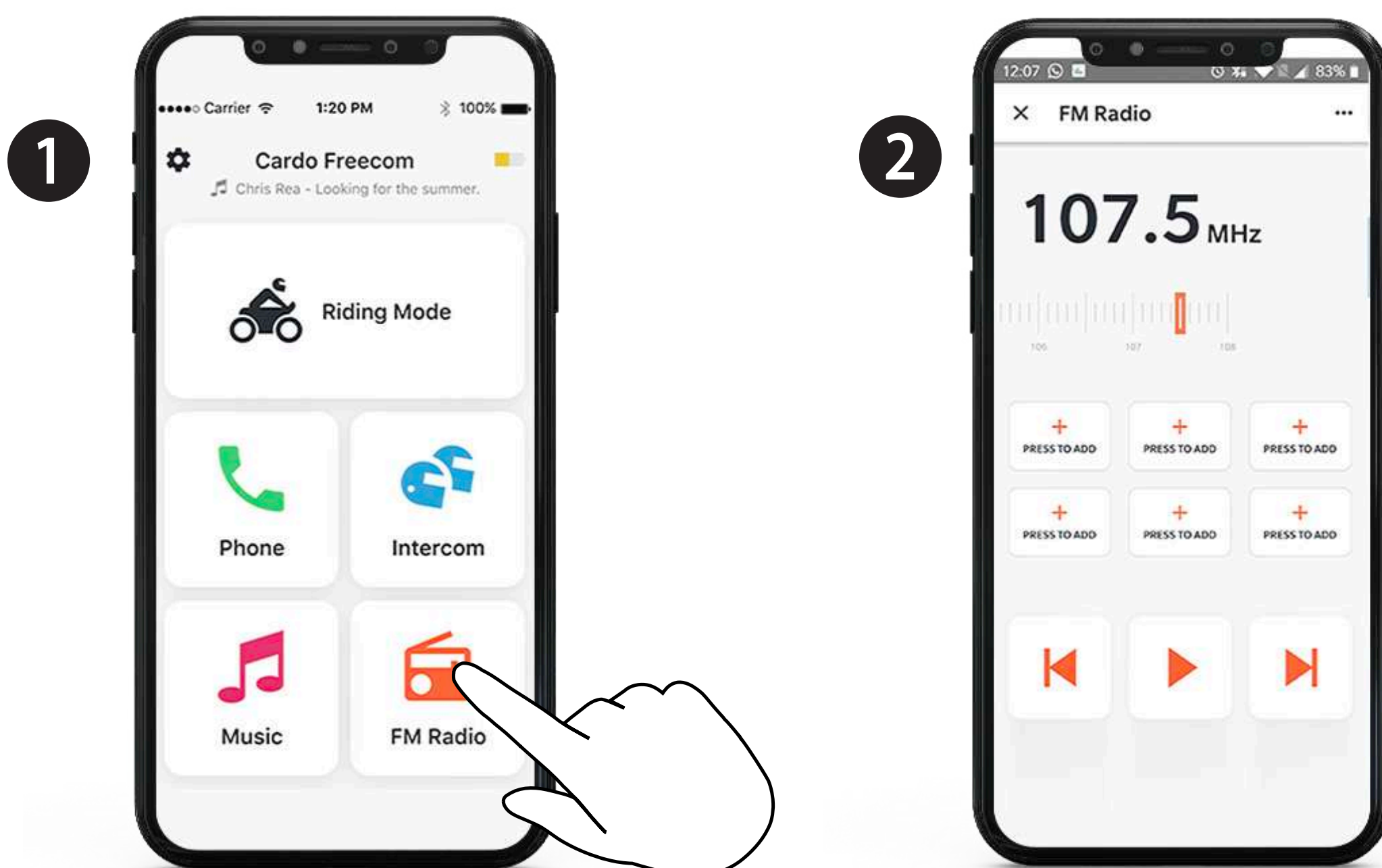

## » スキャンの開始

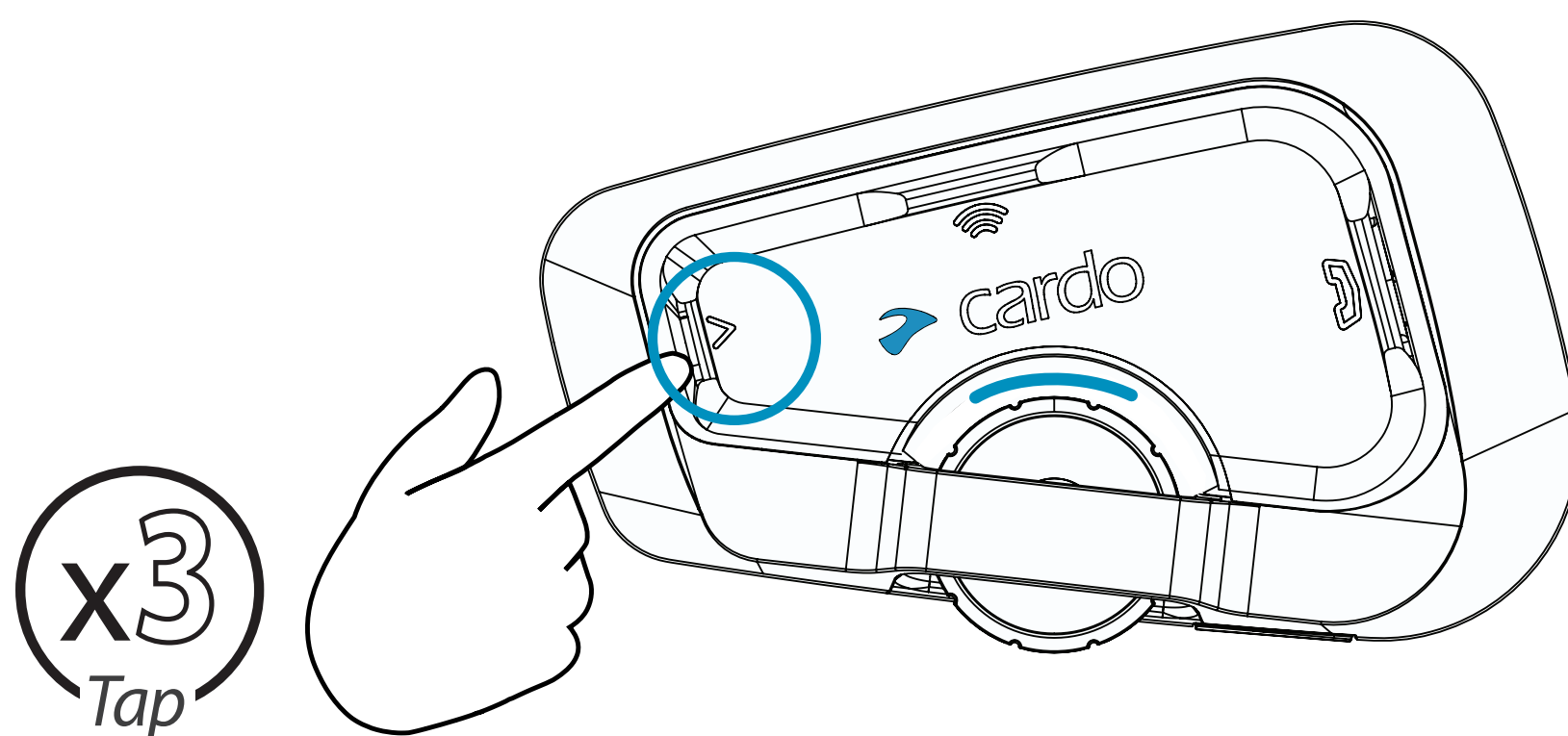

## ■ スキャンの中止

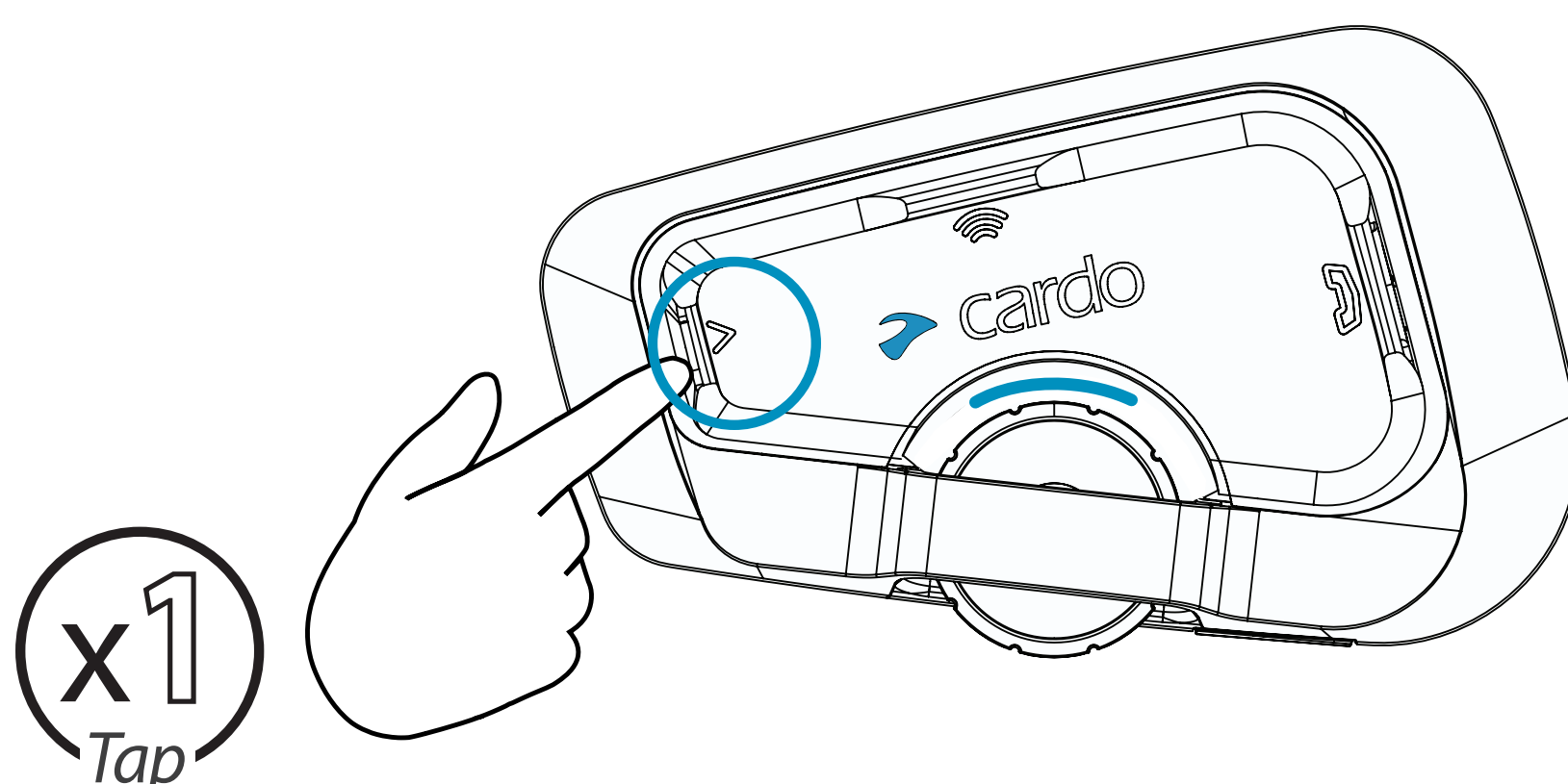



# ラジオ

 オン

---

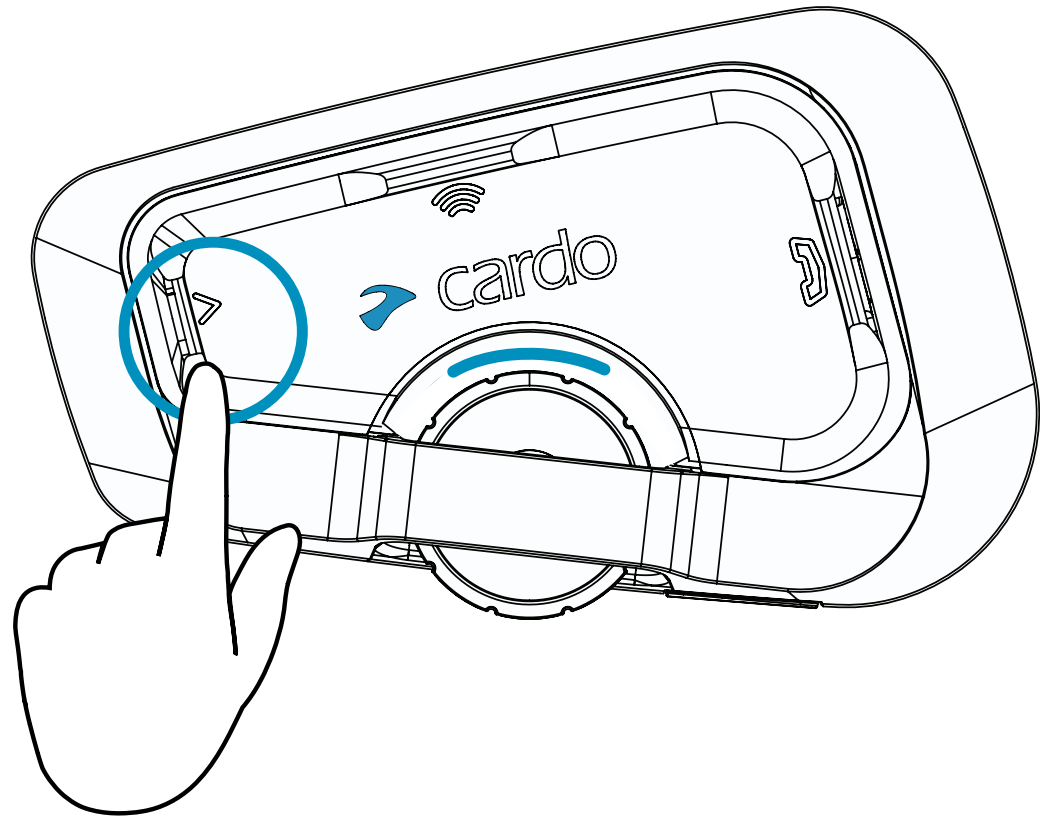
**x2**  
Tap



 オフ

---

**x1**  
Tap

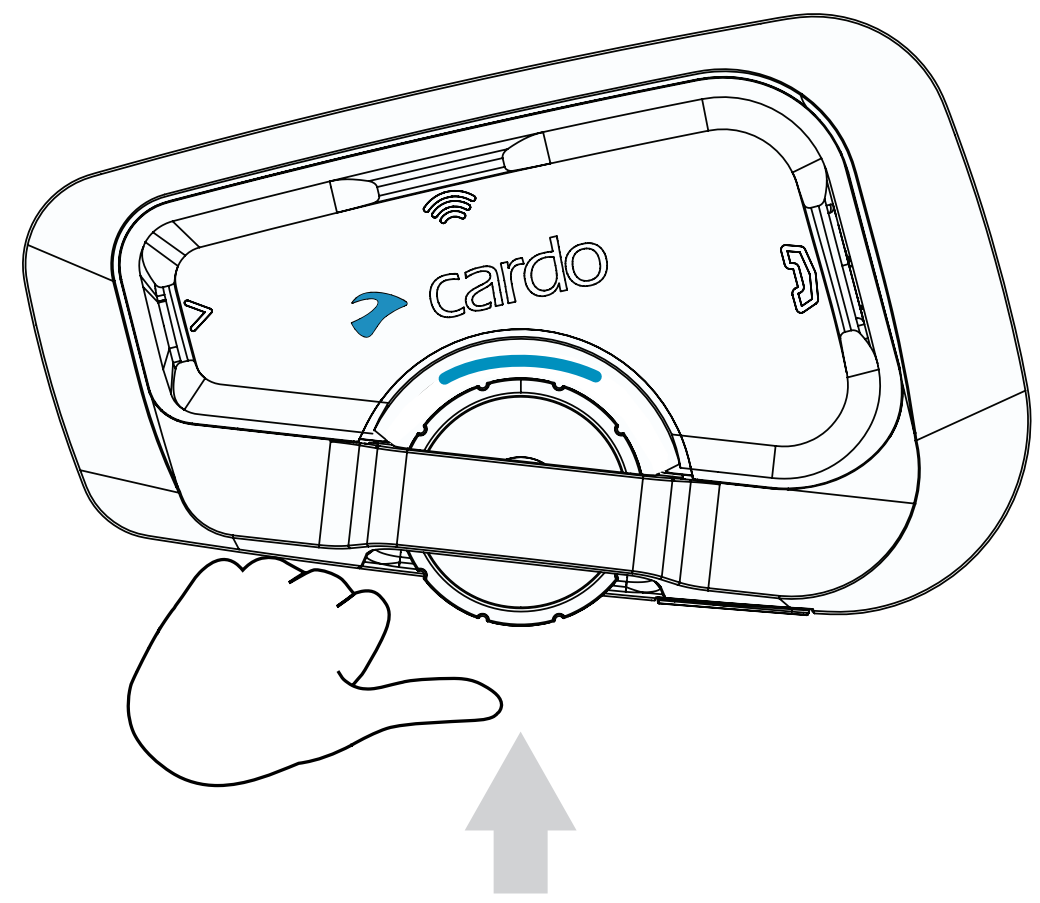

 次のプリセットへ

---

**x1**  
Tap

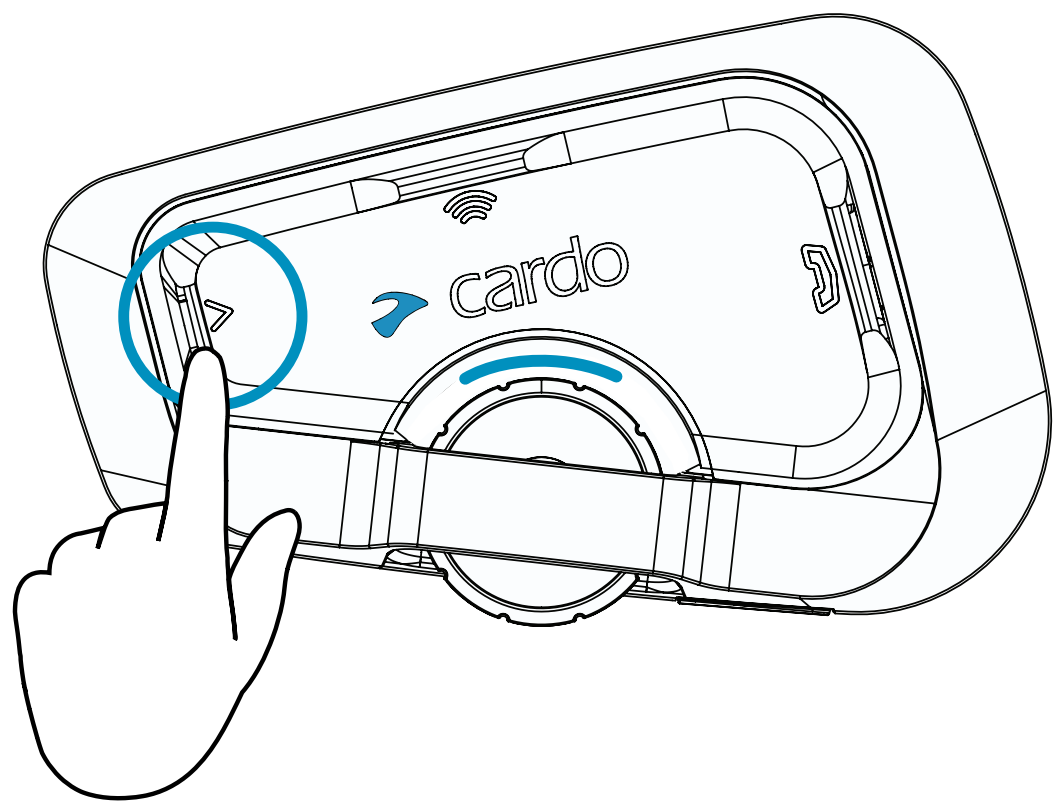

 次のプリセットへ

---

**x2**  
Tap

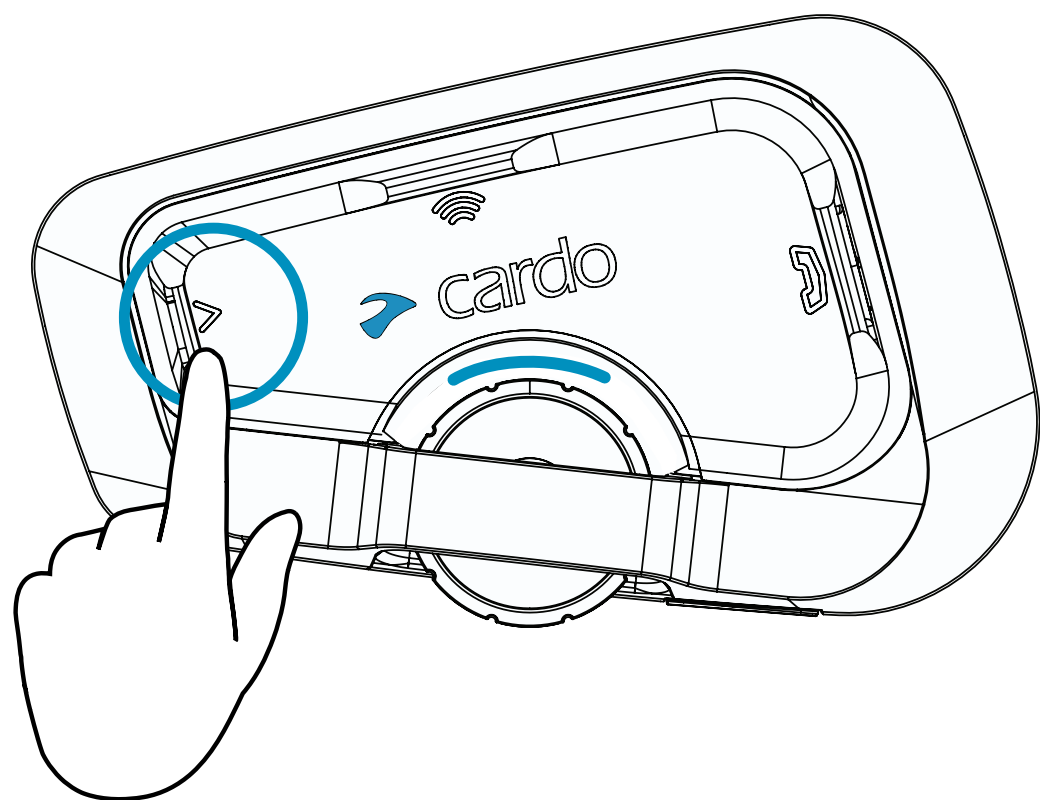



# ソースの切替



音楽からラジオへ

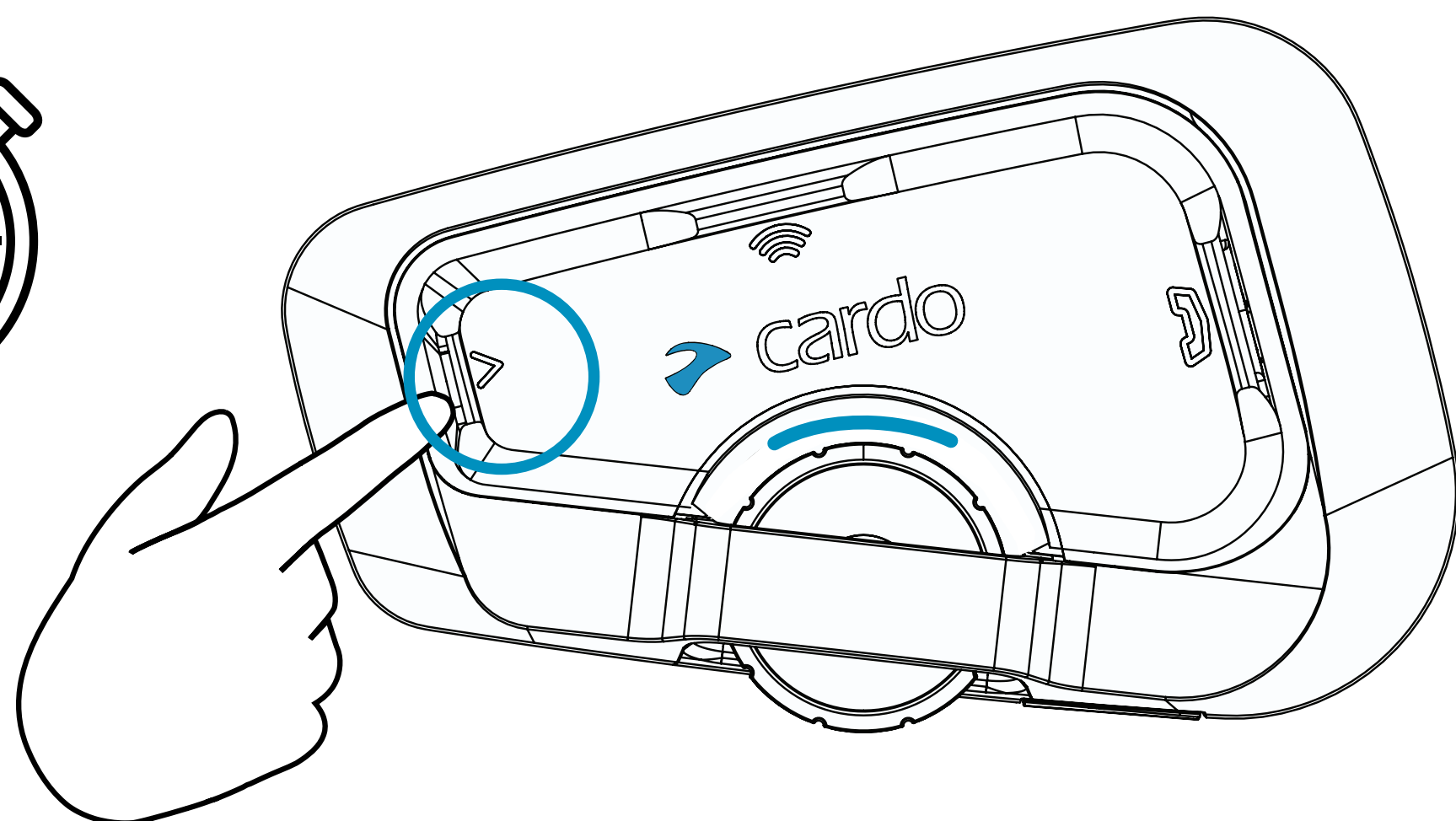

ラジオから音楽へ

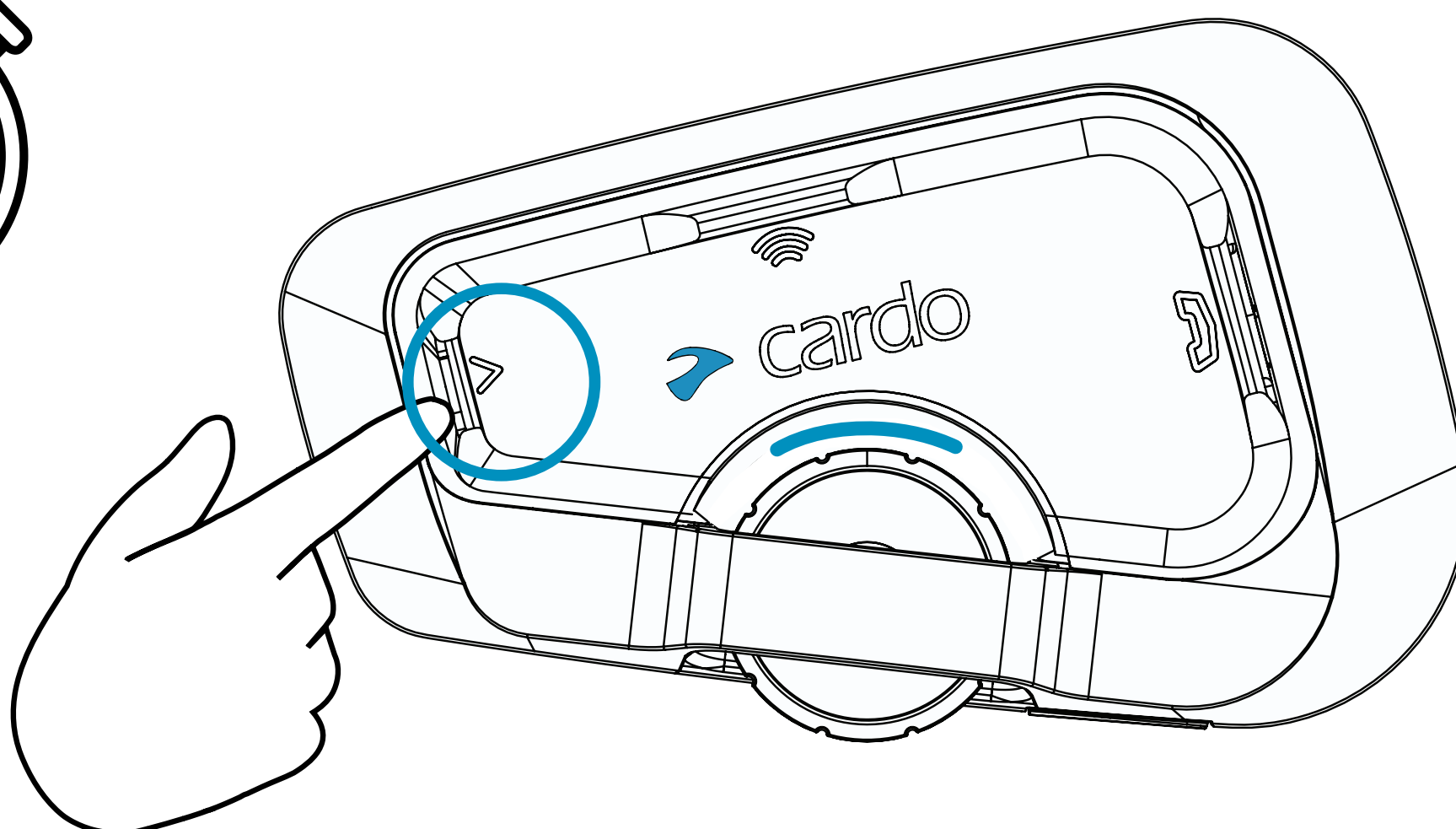

# 電話



応答

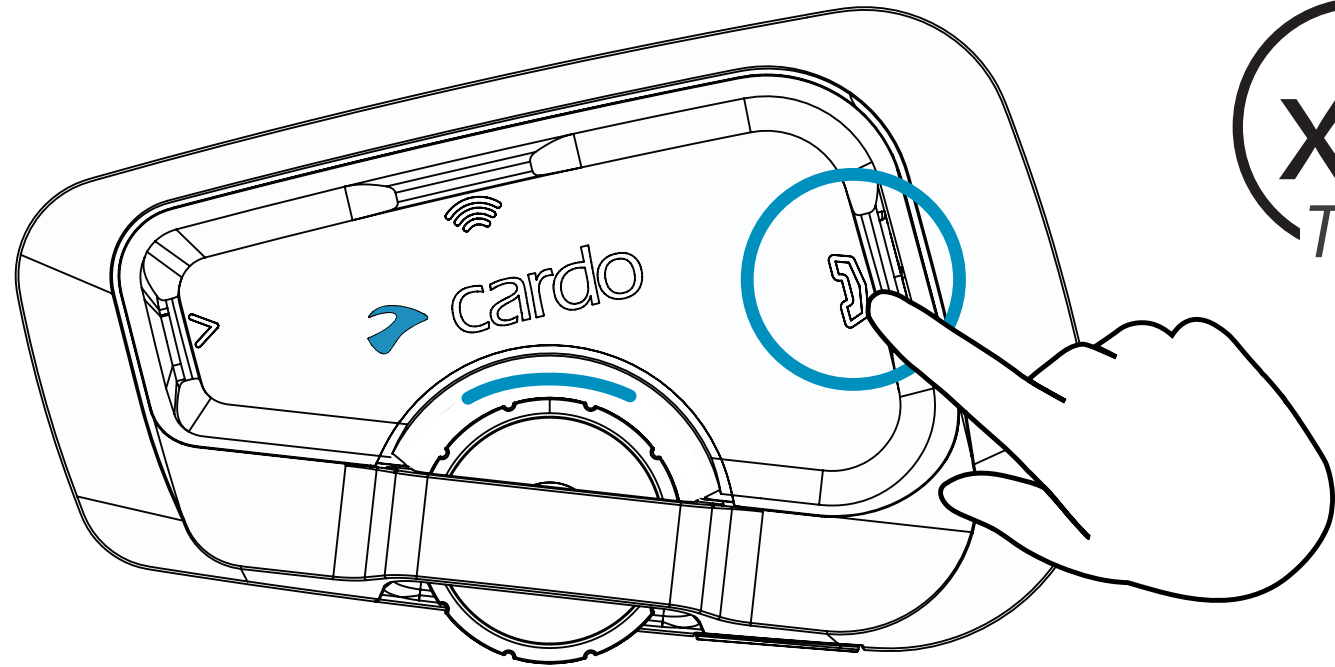

x1  
Tap



無視

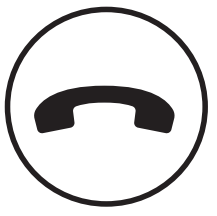
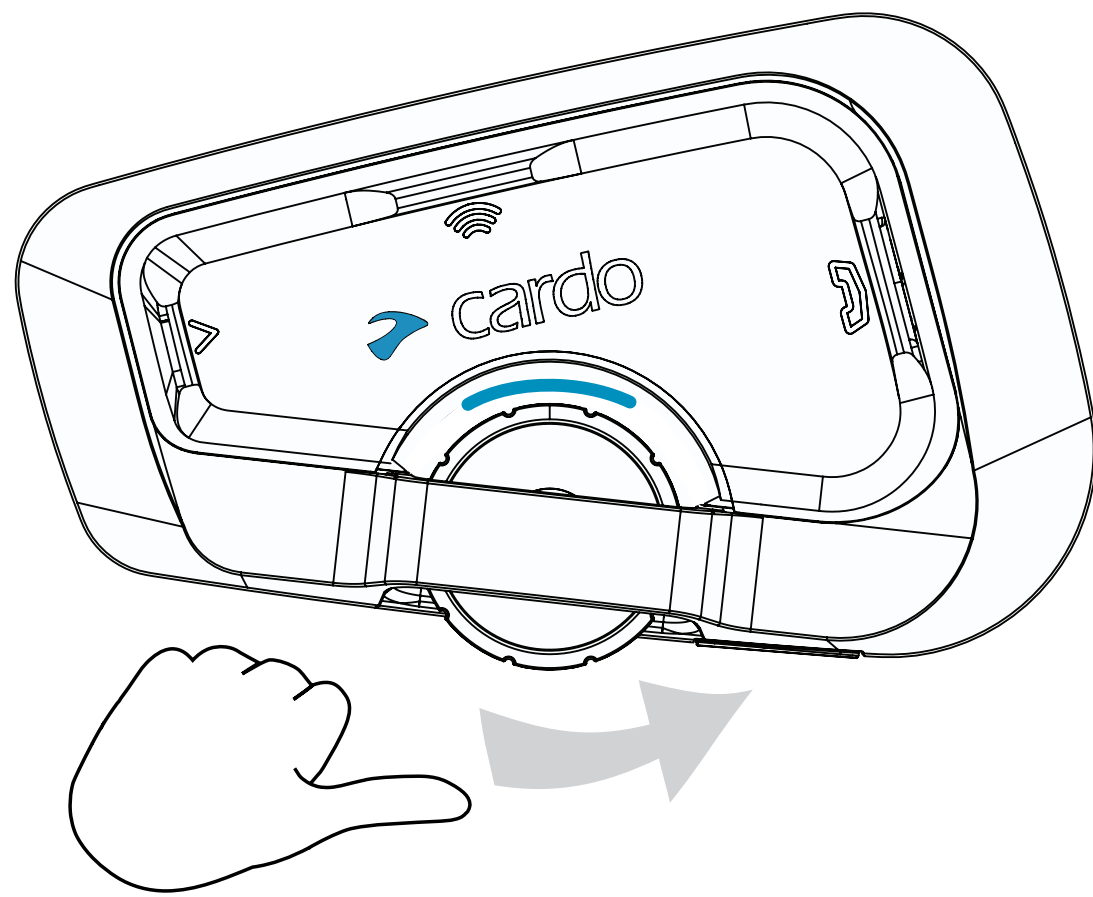

通話終了

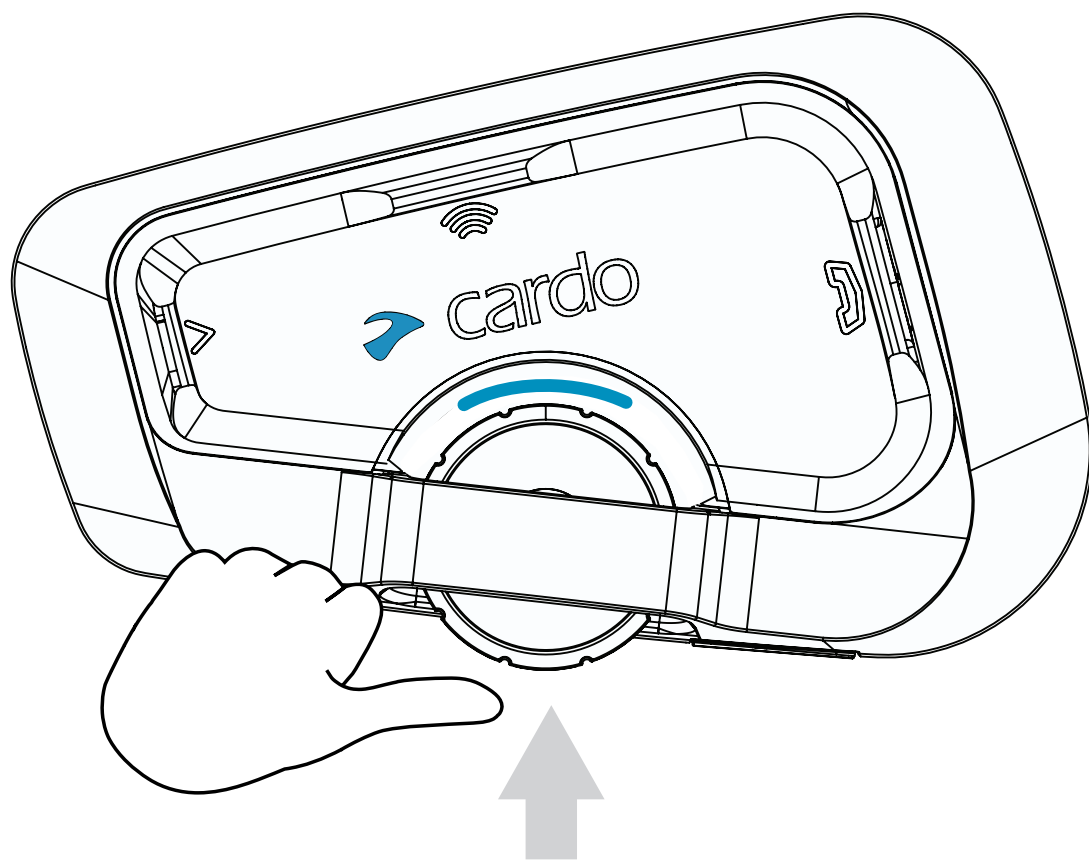

x1  
Tap



リダイヤル

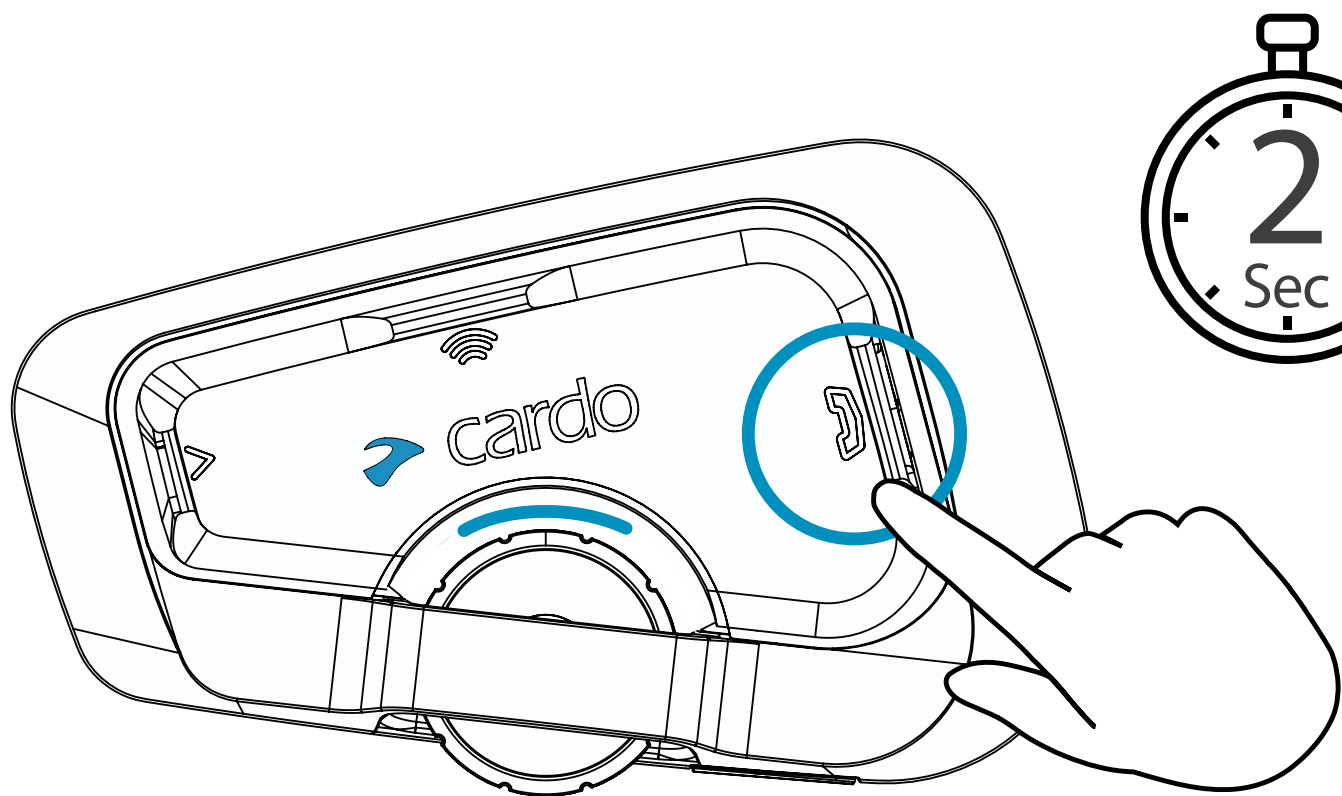

2  
Sec

## ★ スピードダイヤル

番号の設定

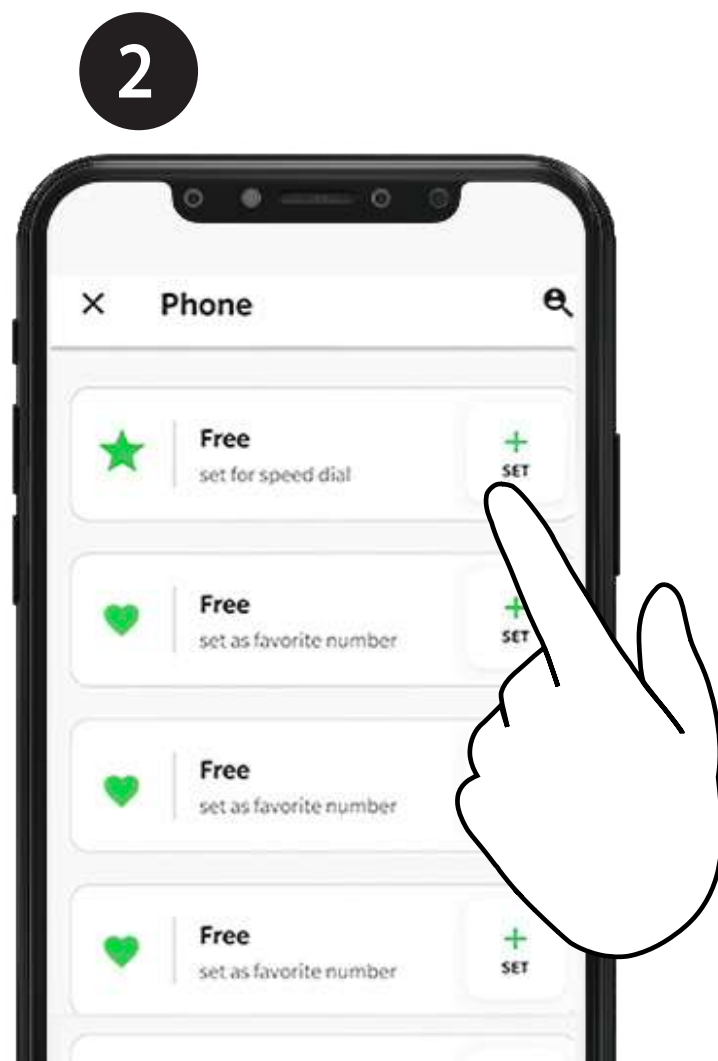
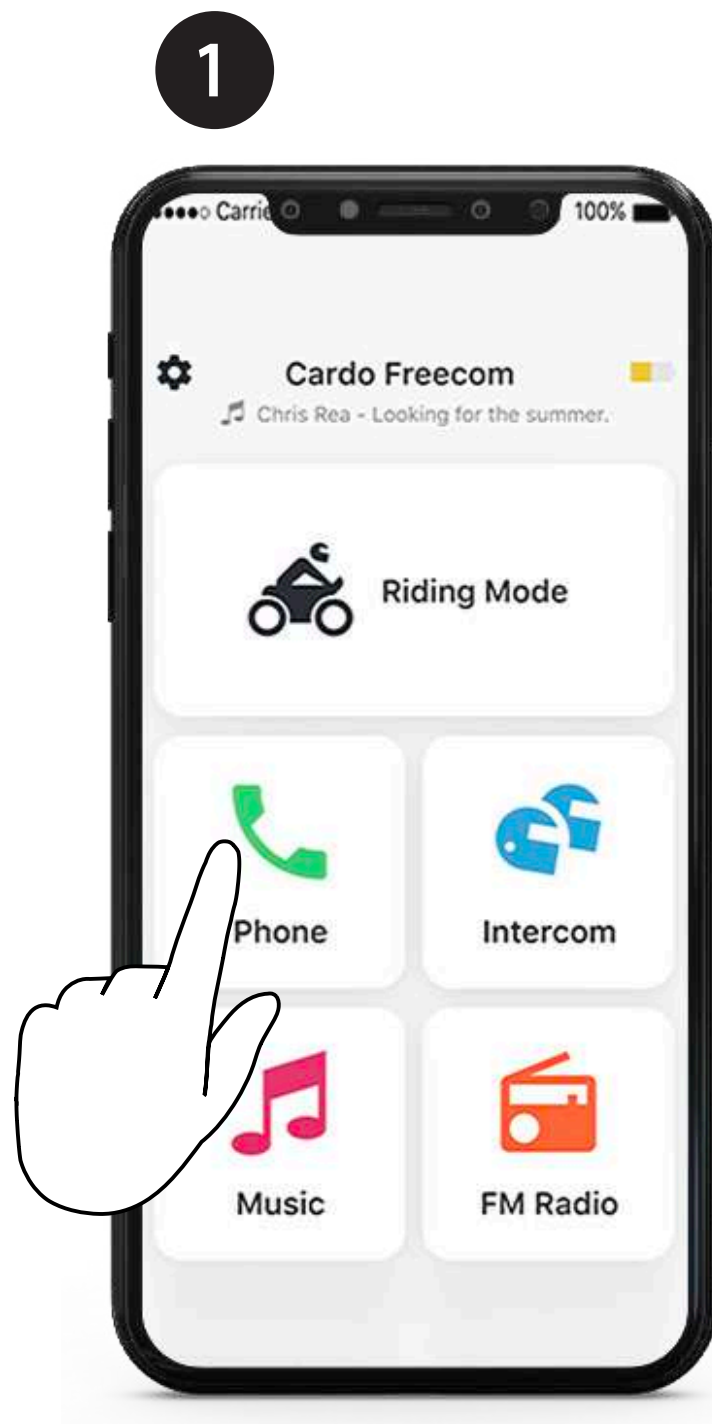

## ★ スピードダイヤルで電話をかける

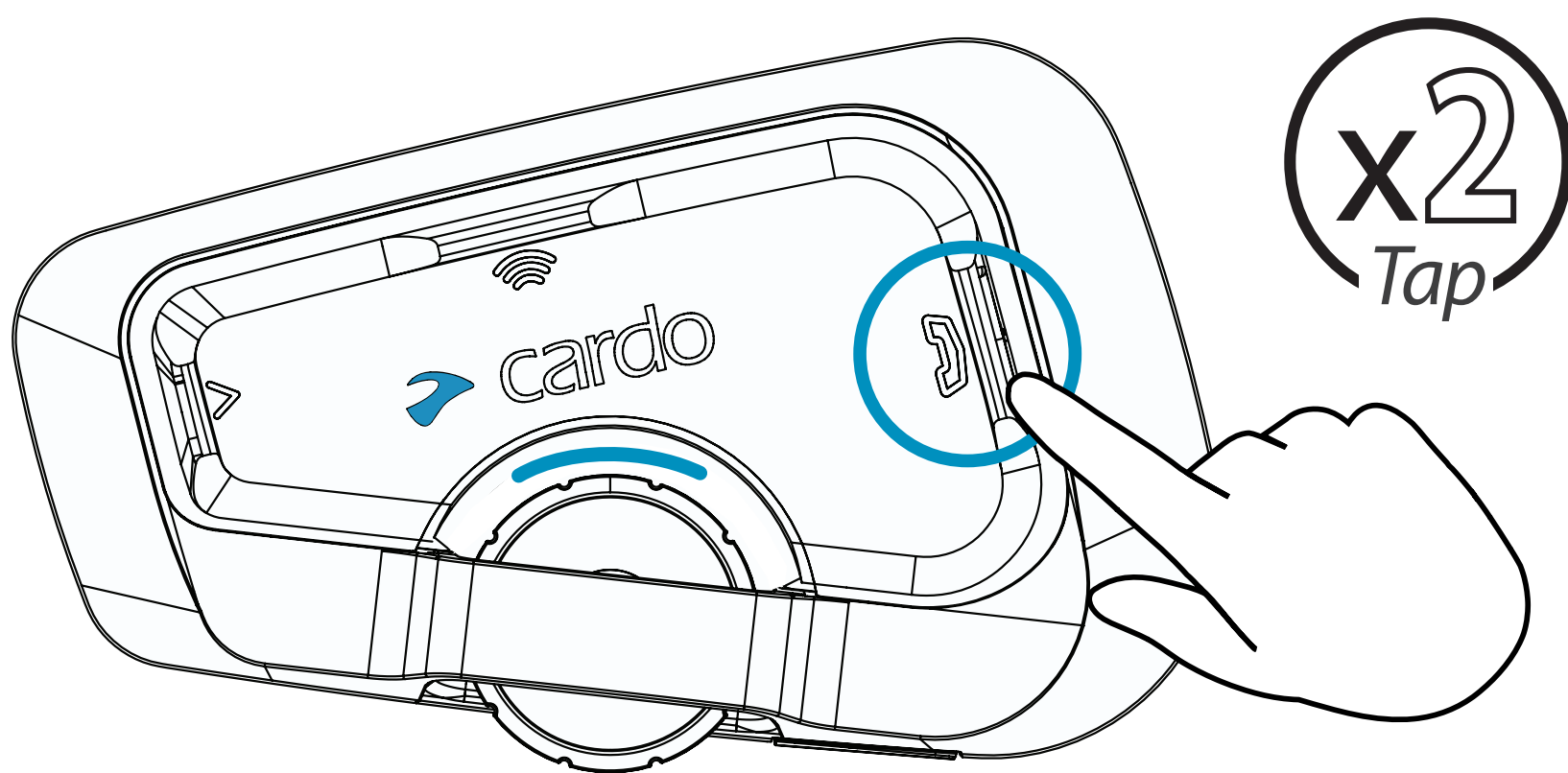

# Bluetooth インターコム | 蓝牙对讲机

## ペアリング

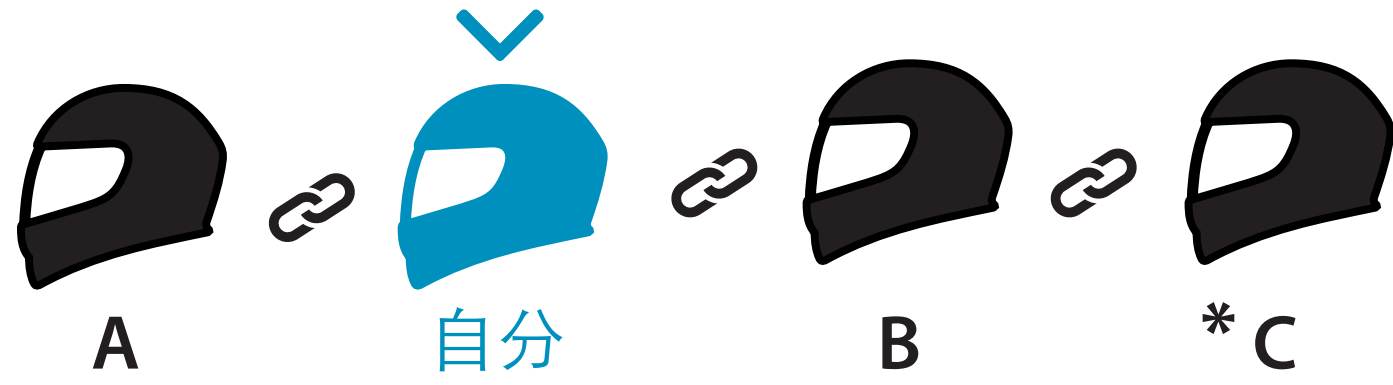

### ライダーAとペアリング

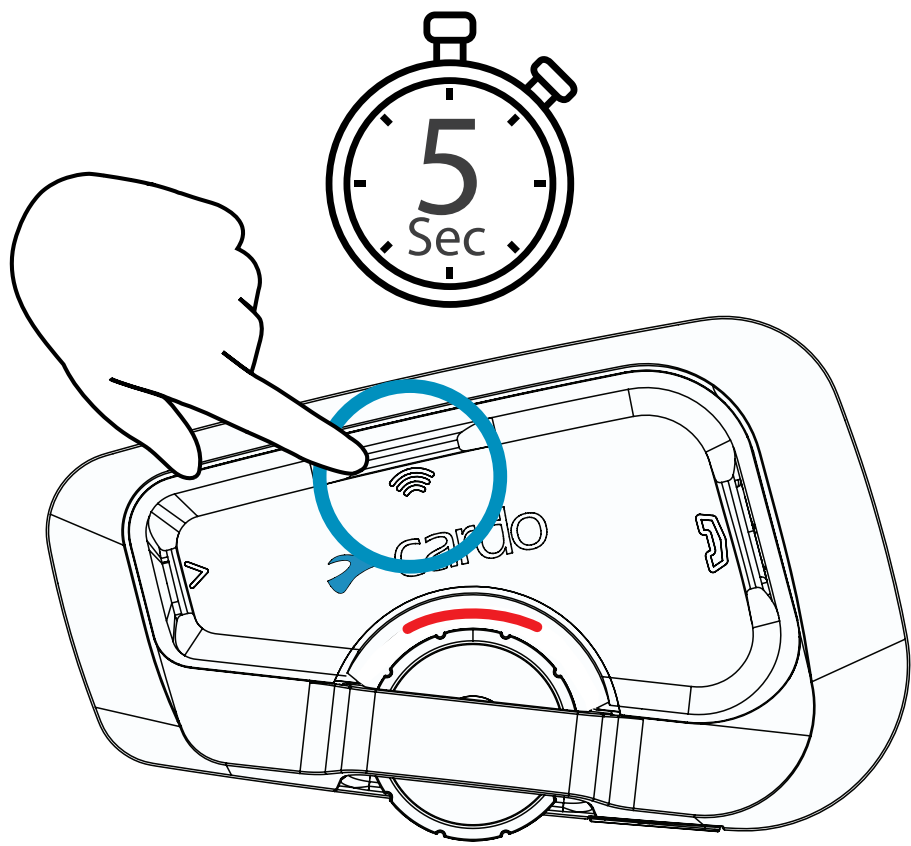

LED 赤



### ライダーBとペアリング

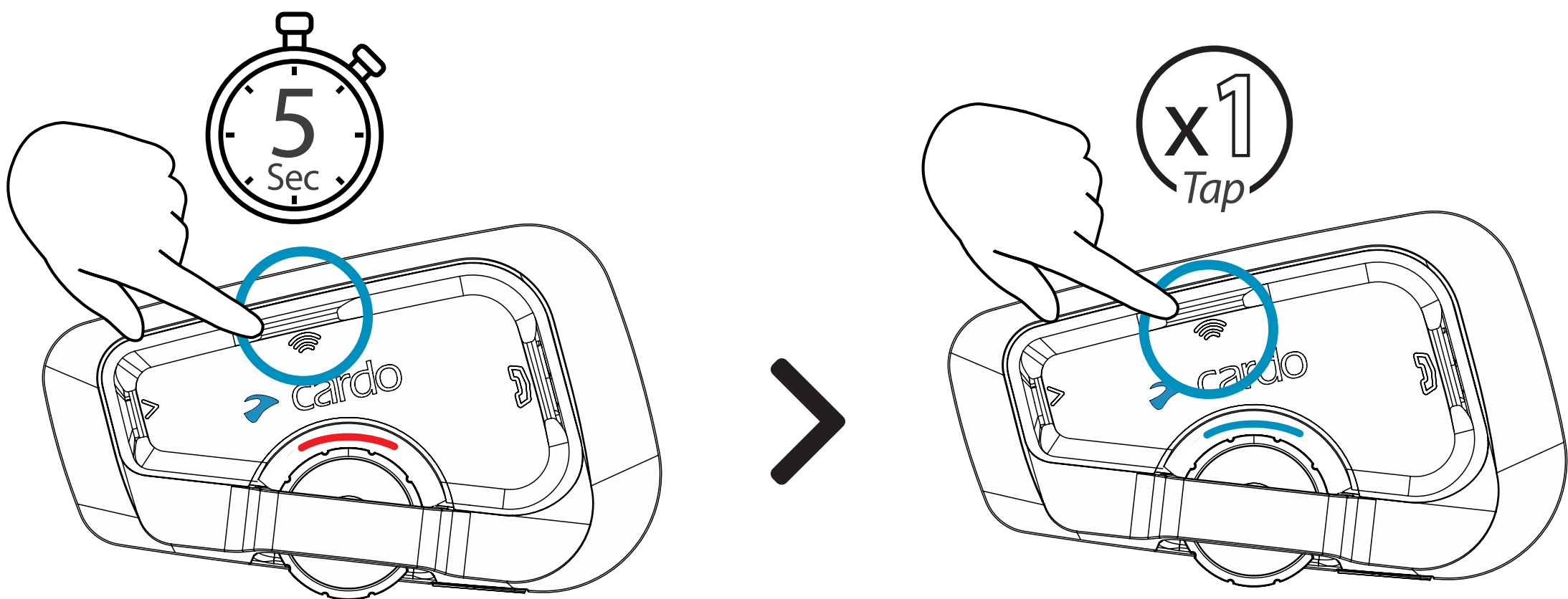

LED 赤



LED 青



\* ライダーCはライダーBに接続する必要があります

# Bluetooth インターコム | 蓝牙对讲机



インターコムの呼出し / 終了

ライダー A

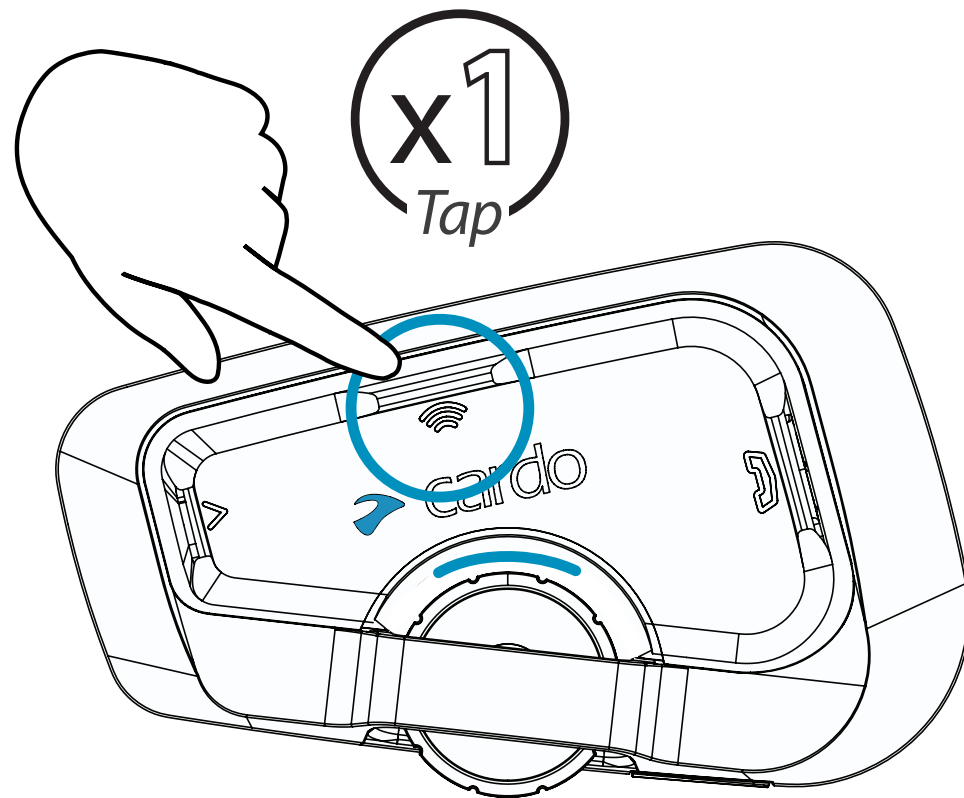

ライダー B

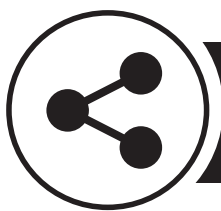
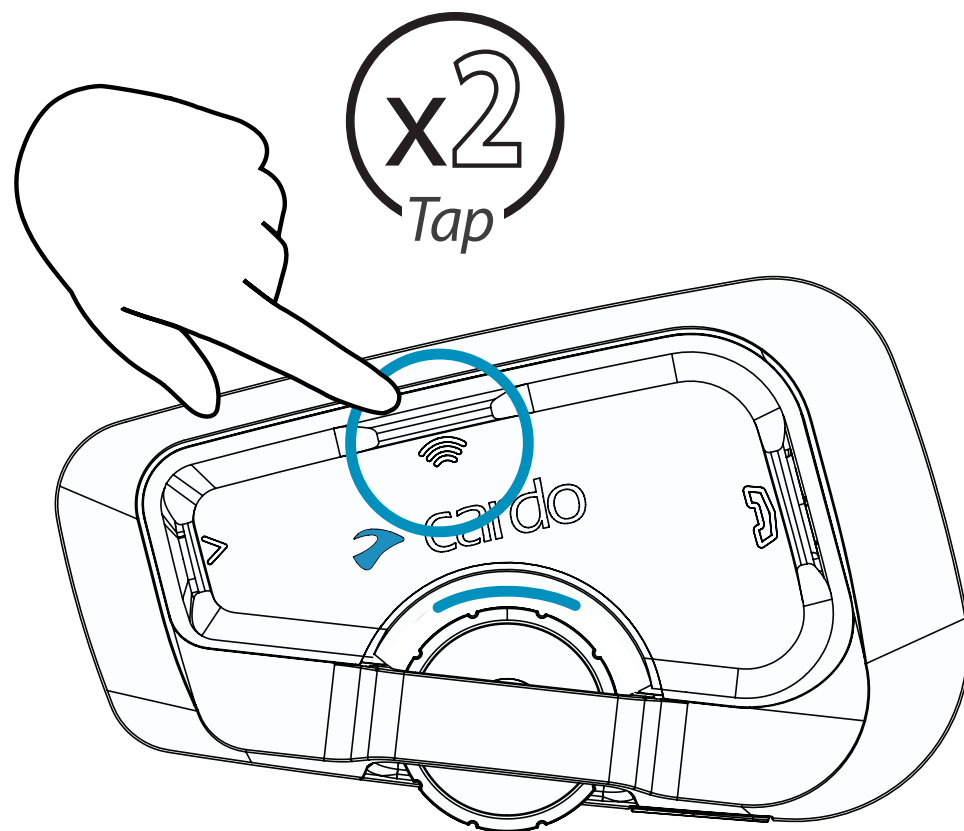

共有



音楽の共有

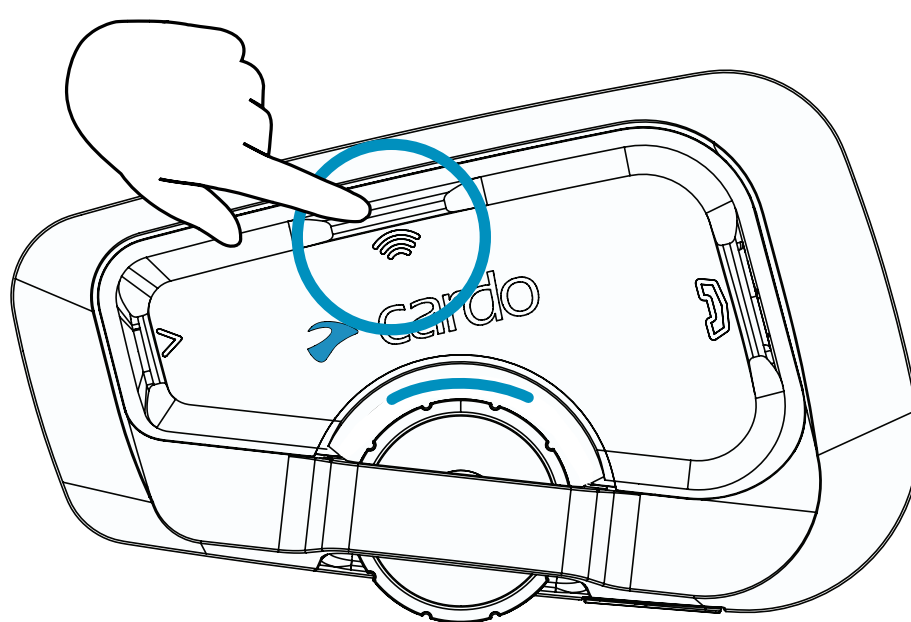

電話の共有

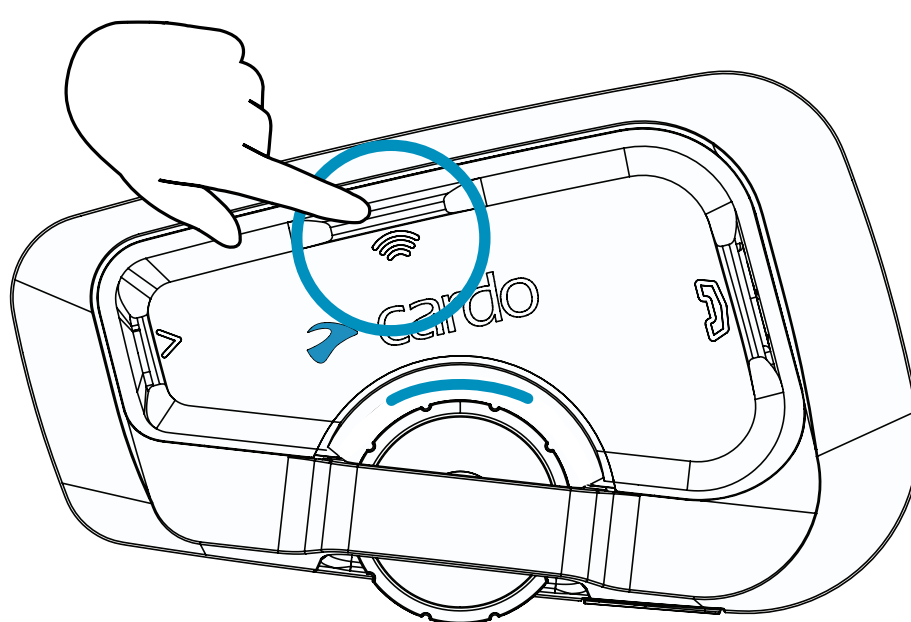
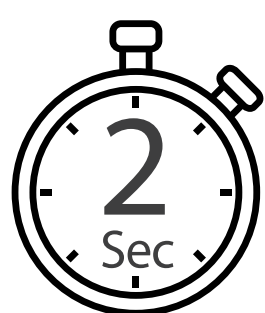

# GPSのペアリング

## 1 ステップ 1

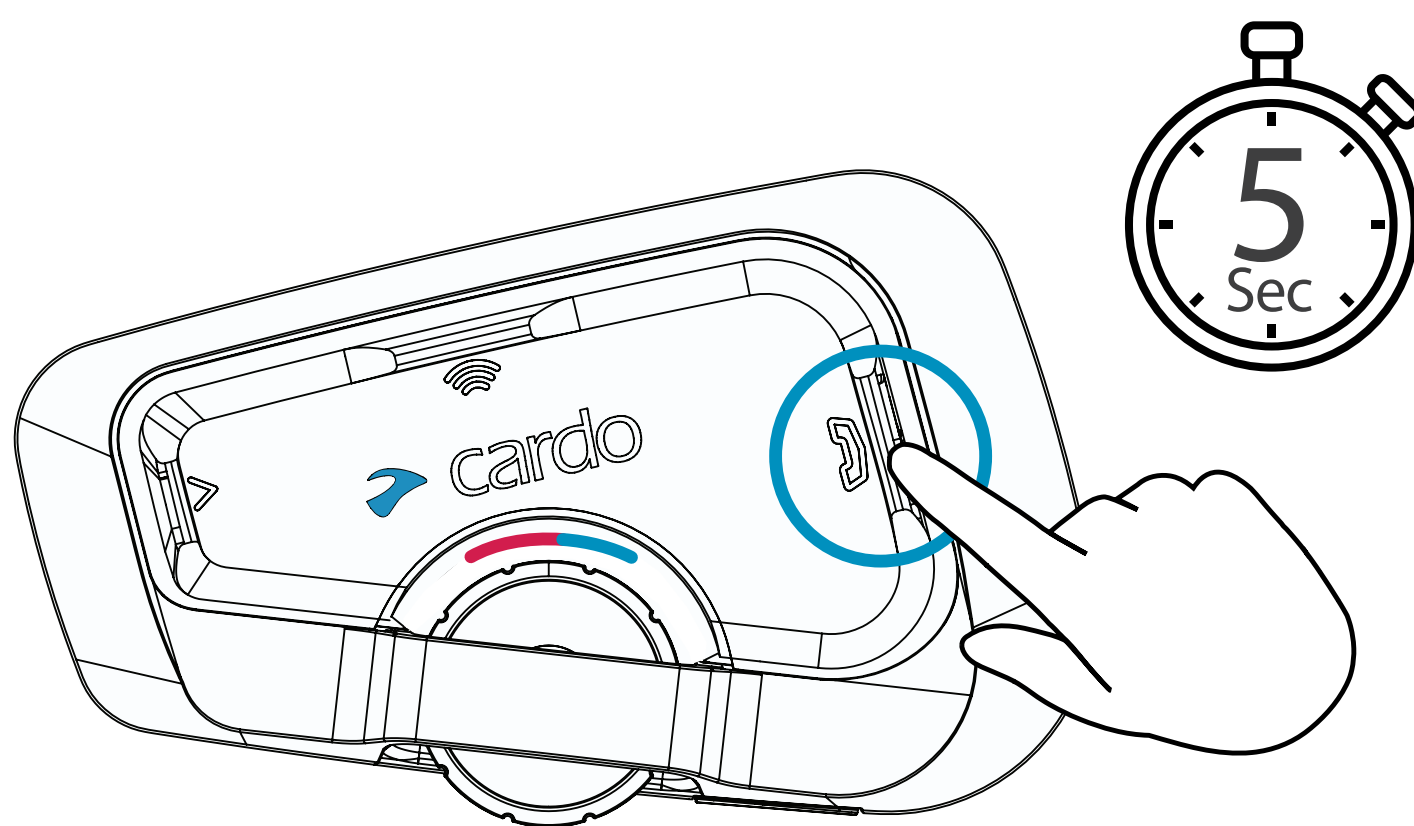

LED 赤 & 青



## 2 ステップ 2

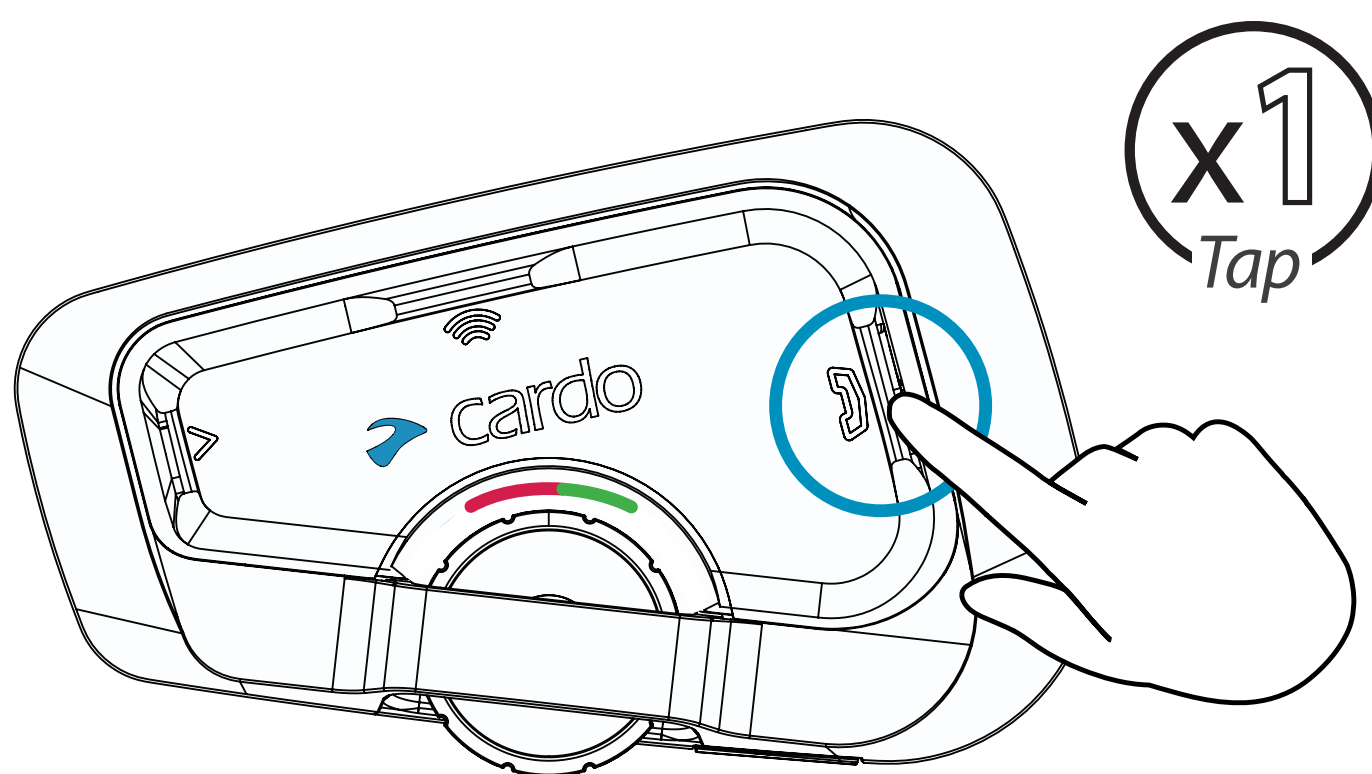

LED 赤 & 緑



## 3 ステップ 3



# 语音命令 - 一直开启!



- 応答
- 無視
- “へい カルド 電話 終了”
- “へい カルド 短縮”
- “へい カルド リダイヤル”



- “へい カルド ミュージック”
- “へい カルド ミュージック オフ”
- “へい カルド 次”
- “へい カルド 前”
- “へい カルド ミュージックシェア”



- “へい カルド ラジオ”
- “へい カルド ラジオ オフ”
- “へい カルド 次”
- “へい カルド 前”



- “へい カルド インカム”
- “へい カルド インカム 終了”



- “へい シリ”
- “オッケー グーグル”



- “へい カルド ボリューム アップ”
- “へい カルド ボリューム ダウン”
- “へい カルド ミュート”
- “へい カルド ミュート オフ”

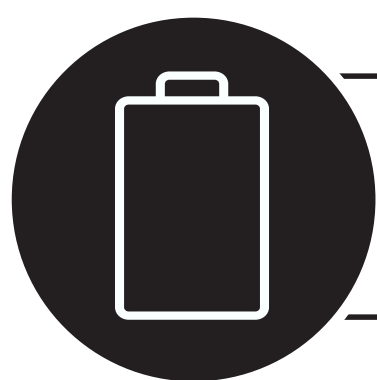

- “へい カルド バッテリー”

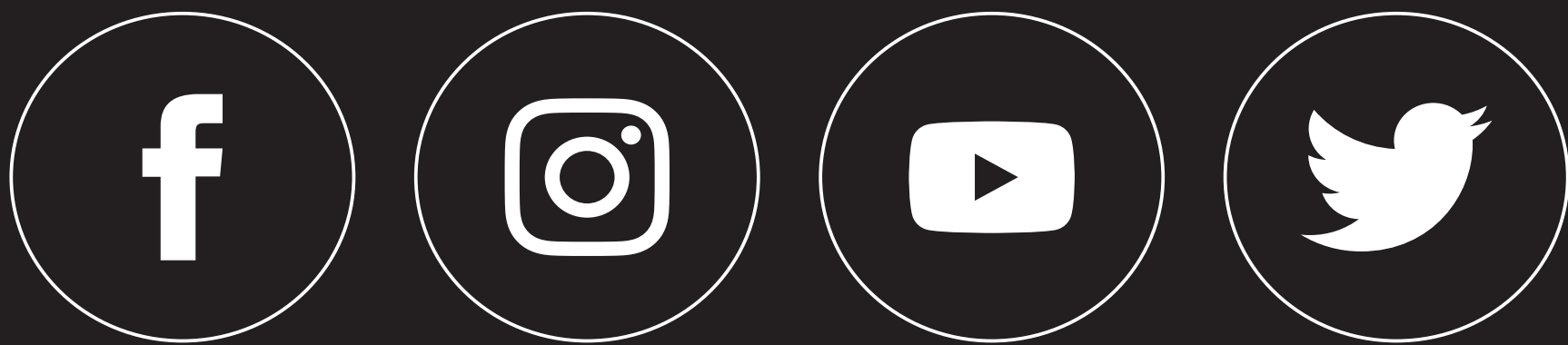

[Cardosystems.com](https://Cardosystems.com)

[Cardosystems.com/update](https://Cardosystems.com/update)

[Cardosystems.com/support](https://Cardosystems.com/support)